



DOBEST BRIGHT CO.,LIMITED

中山好倍儿照明有限公司
多贝尔电子科技有限公司

LED Polygonal Light Series Catalog

DOBEST BRIGHT CO.,LIMITED

中山好倍儿照明有限公司
多贝尔电子科技有限公司

Web: www.tracklinearlight.com

Factory Address 1: 3rd Floor, No. 26, Pingbei 1st Road, Nanping Science and Technology Industrial Park, Xiangzhou District, Zhuhai City, Guangdong, P.R. China

Factory Address 2: 2nd Floor, 3rd Floor, No. 15, 1st Street, Hongye Road, Caoer, Guzhen Town, Zhongshan City, Guangdong Province

Email: candy@dobestbright.com / sales@dobestbright.com

Tel/Fax: +86-0756-3338786

Whatsapp: +86-18902868159



ABOUT **DOBEST**

DOBEST management has been working in the LED Lighting industry since 2008 and has had its oversea department since 2012. It is a professional manufacturing enterprise that focuses on the research and development and production of lighting fixtures.

DOBEST based in Zhuhai and Zhongshan Guangdong Province, and there are 2000 m² production line and warehouse in ZhongShan and a 500 m² show room and warehouse in Zhuhai.

www.tracklinearlight.com

DOBEST is a professional manufacturer with R&D and production in one, specializing in Led magnetic track lights, led Linear lights and LED Aluminum Profile, led penal lights, etc. Thanks to our inherited commitments to high QA/QC procedures, our operation process is accredited by ISO9001-2015. All of our product is with ETL, CE(EMC&LVD), RoHS, and SAA certifications.

DOBEST has a professional optical design, appearance design, thermal design, structure design, and electronic design engineers team. Our marketing team will collect your requirements, timely feedback to the relevant departments to solve your problems, provide quality and fast after-sales service.

www.tracklinearlight.com

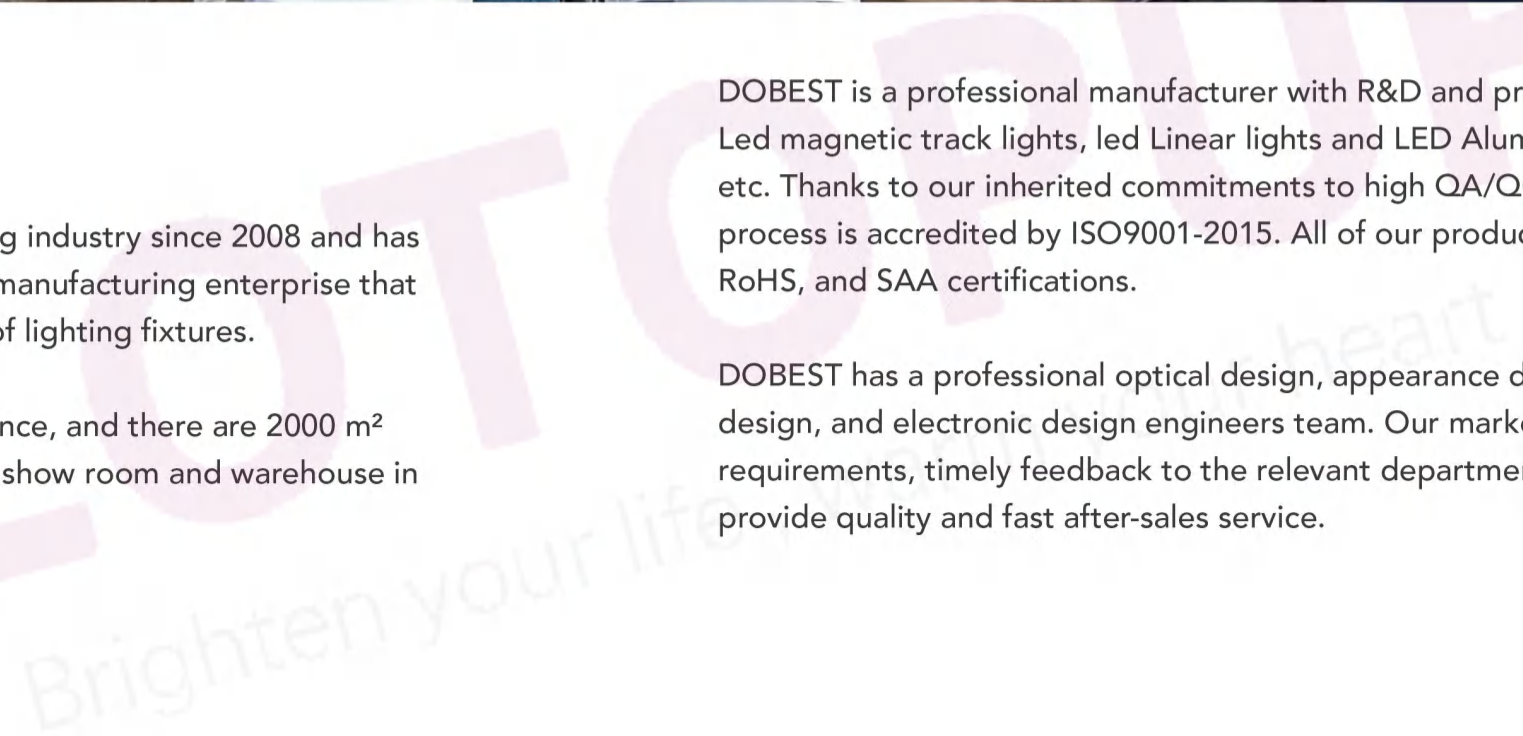

FACTORY

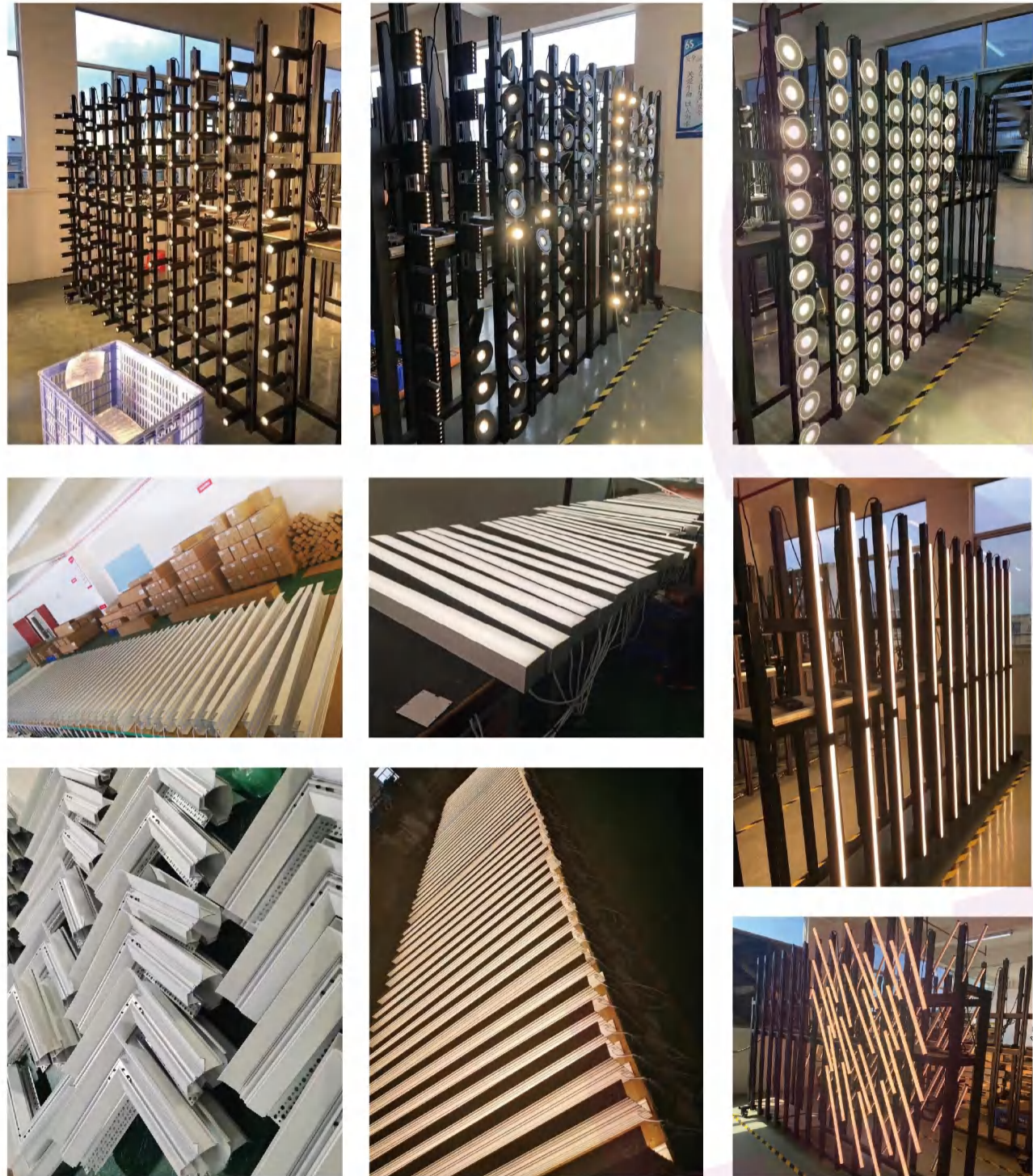

Brighten your life

CERTIFICATES AND EXHIBITIONS

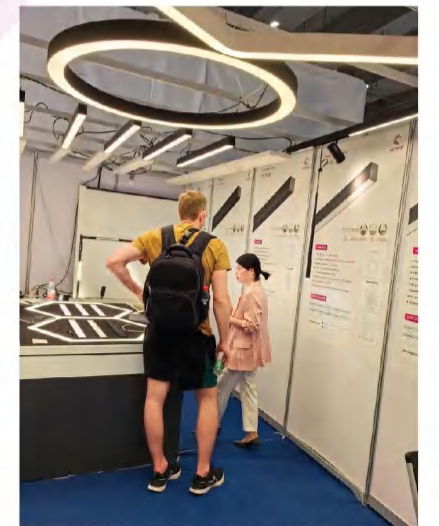
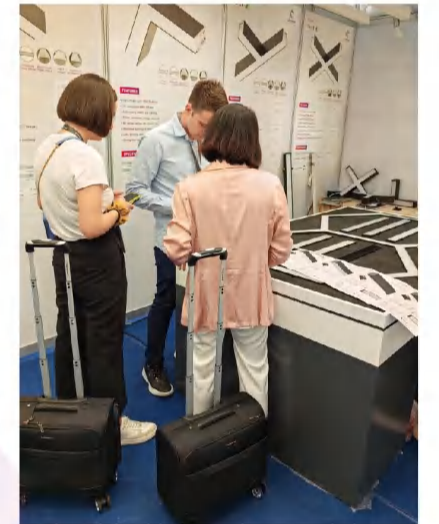

DOBEST BRIGHT PROJECT

- Light Planning
- Light Calculation (DIALUX)
- Photometric Simulation
- Customizing Light Solutions
- Comparison Studies
- Product Sourcing

Dobest Engineering Services

People make a successful organization. Dobest has a team of motivated light professionals to offer a multitude of light related services to find the best result for your projects

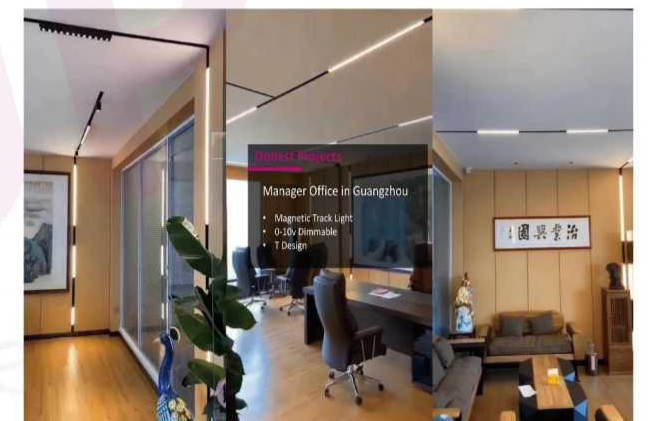
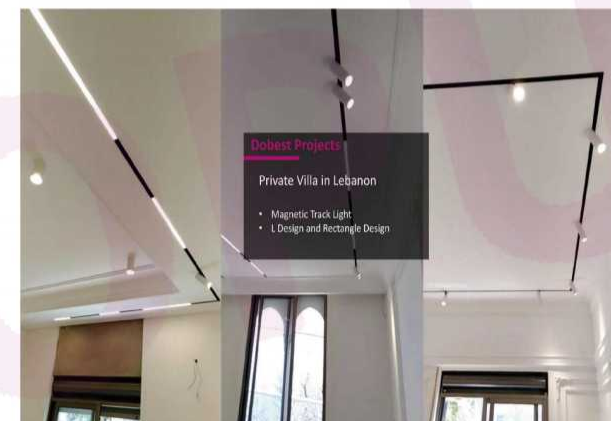
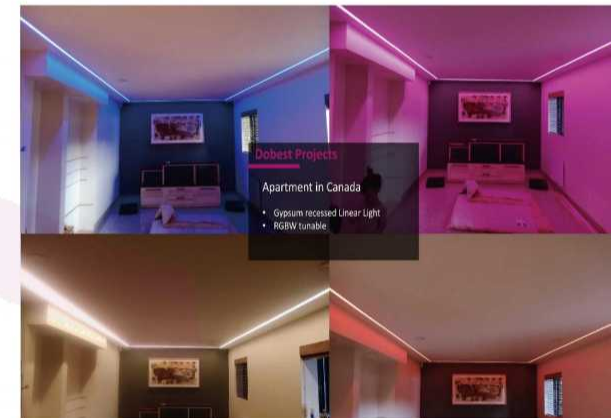
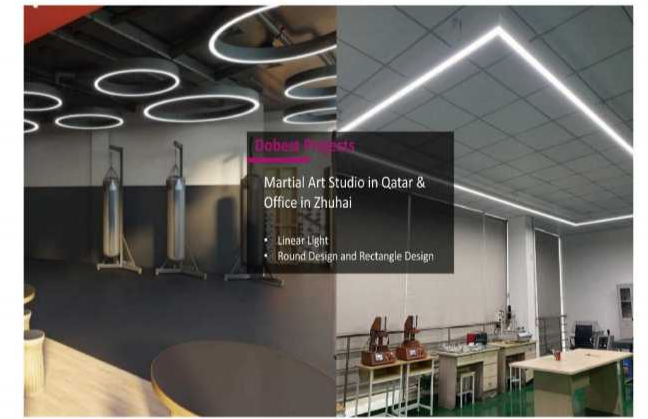
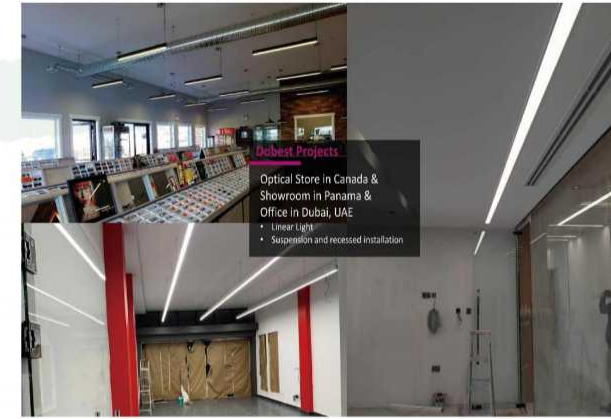

Dobest works together with clients to create fabulous customized lighting. Strong supply chain allow us to offer customized lighting service with reasonable price, satisfied quality. Noted: Only photos that the client has agreed to make public will be displayed.

Brighten your life, warm your heart

第1.0代多边形灯 Polygonal led lights V1.0

- 2015年10月开始研发；
- 2015年12月少量推广测试；
- 2016年3月正式上市。
- Research and development commenced in October 2015.
- Limited promotional testing in December 2015.
- Official market launch in March 2016.

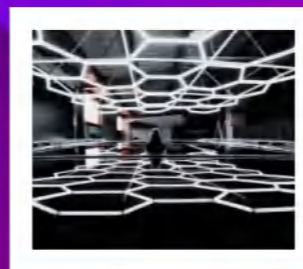

侧面出线系列，灯管均为565mm。
每条灯管灯体侧面出线，需要配备1拖12线进行电路连接。
Side Wiring Series, all light tubes are 565mm.
Each light tube body has side wiring,
and requires a 1-to-12 cable for circuit connection.

第2.0代多边形灯 Polygonal led lights V2.0

- 2016年1月开始基于第1.0代的基础上进行线路设计升级；
- 2016年5月少量推广测试；
- 2016年8月正式上市。
- Commenced circuit design upgrades based on the 1.0 generation in January 2016.
- Conducted limited pilot testing in May 2016.
- Officially launched in August 2016.



手动接线系列，增加440mm和1175mm灯管。
设计标准工位尺寸2410*4700mm，区分标准和定制化产品
Manual Wiring Series, adding 440mm and 1175mm light tubes.
Designed for standard workstation dimensions of 2410x4700mm
distinguishing between standard and customized products.

第3.0代多边形灯 Polygonal led lights V3.0

- 2018年4月开始基于第2.0代的基础上进行连接方式设计升级；
- 2018年7月少量推广测试；
- 2018年10月正式上市。
- Commenced connection design upgrades based on the 2.0 generation in April 2018.
- Limited promotional testing in July 2018.
- Officially launched in October 2018.



快接系列，基于第2.0代升级了连接方式，
由于连接头全新设计，标准尺寸相应变化为2433*4840mm
The Quick Connect Series, upgraded to the 2.0 generation,
features a new connection method.
Due to the redesigned connectors,
the standard dimensions have correspondingly changed to 2433*4840m

第3.1代多边形灯 Polygonal led lights V3.1

- 2019年6月新设计了加宽尺寸的蜂窝灯，宽度做到8cm；
- 2019年9月少量推广测试；
- 2019年10月正式上市。
- New design with an expanded size of the honeycomb lamp,
achieving a width of 8cm, was introduced in June 2019.
- A limited promotional test was conducted in September 2019.
- Officially launched in October 2019.

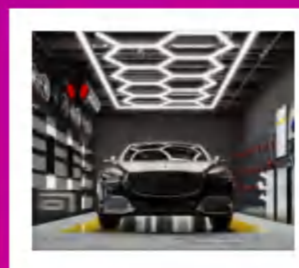
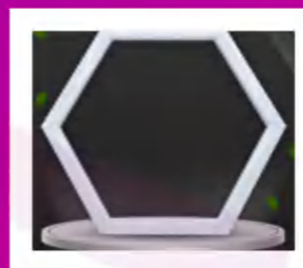

第3.2代多边形灯 Polygonal led lights V3.2

- 2023年4月针对国际认证标准进行接电方式升级；
- 2023年7月少量推广测试；
- 2023年8月正式上市。
- Upgrade power connection method in accordance with
international certification standards in April 2023.
- Limited promotional testing in July 2023.
- Official market launch in August 2023.

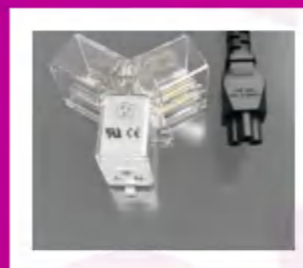

第4.0代多边形灯 Polygonal led lights V4.0

- 2021年7月针对客户需求在第3.0代的基础上增加调光、
调色温的功能设计；
- 2021年8月少量推广测试；
- 2021年9月正式上市。
- we designed the addition of dimming and color temperature
adjustment features based on customer demand for the 3.0
generation in July 2021.
- A limited promotional test was conducted in August 2021.
- Officially launched in September 2021.

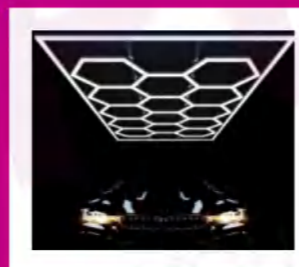

调光配置使得原白光产品可以更节能；
调色配置不仅将美容照明更专业化，
还使得蜂窝灯的应用场景更多样化，
不再只用于汽车美容店面。
Dimming configurations make the original white light product more energy-efficient.
Color adjustments not only enhance the professionalism of beauty lighting but also
diversify the application scenarios of honeycomb lights,
no longer limited to just automotive detailing shops.

第5.0代多边形灯 Polygonal led lights V5.0

- 2022年6月针对客户需求在第三代的基础上增加RGB功能；
- 2022年11月少量推广测试；
- 2022年12月正式上市。
- Added RGB functionality based on customer demand
for the third generation in June 2022.
- Limited promotional testing in November 2022.
- Official market launch in December 2022.

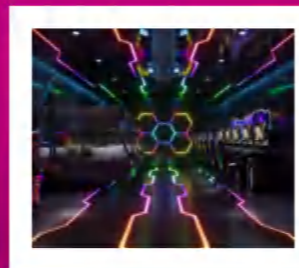

>>> Polygonal Light V6.1

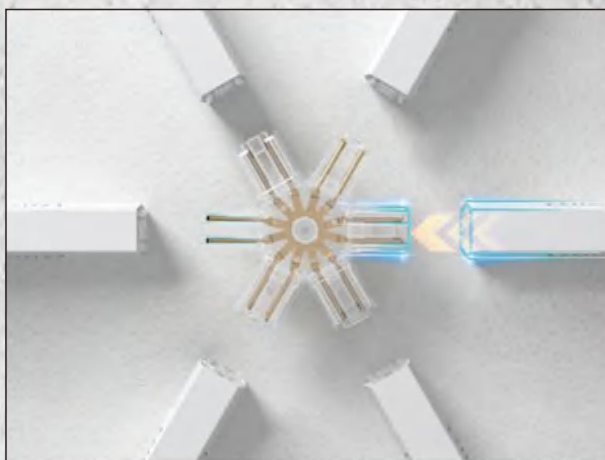

Novel shape, multiple connector options, diversified design, not limited to shape; Support is not necessary, easy to install; One step connection; Personalized lighting structure works not only lighting but decoration.

新颖造型,多款连接头设计,造型多样化,不拘于形; 无需支架,安装便捷;灯具拼接采用快插接电方式 自动卡位无需手接,安装一步到位; 个性化灯体结构,装饰照明两不误。

The side hole design allows for one-step installation, and can be easily disassembled and replaced after installation and fixation, without worrying about after-sales service.

侧面开孔,装卸轻松。
采用侧面孔位设计,安装一步到位的同时,可在安装固定后轻松拆卸更换,售后无忧。

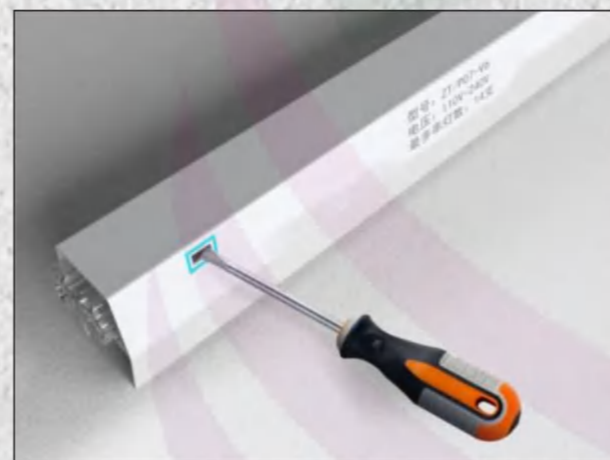

Fireproof PC material, lighter material, multifunctional for widely application. Independently develop power supply, more professional configuration, effectively guarantee the service life of lamps;

防火PC外壳设计,更轻便,应用场景更广泛。
自主研发电源,配置更专业,有效保障灯具使用寿命。

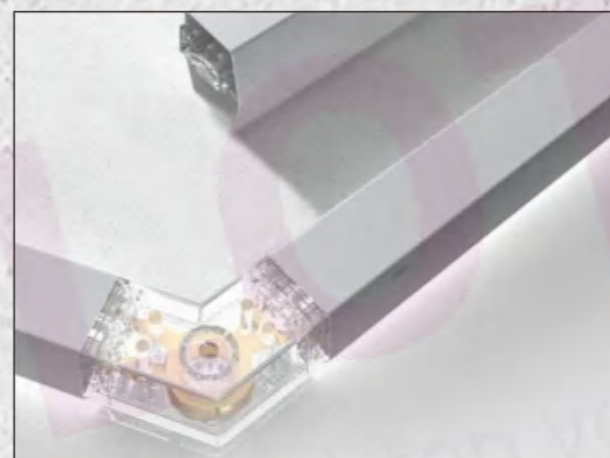

Carefully select imported LED chips, high-brightness, guaranteed quality; high-transparency PC cover, uniform illumination, professionally guard work scenes.

严选进口LED芯片,高亮光源,品质保证;
高透PC面罩,光照均匀,专业守护工作场景。

Polygonal Light V6.1 >>>

ZT6102



Specification Parameter 规格

Item Code 型号	ZT6102
Space Size 尺寸	4828*2796mm
Voltage 电压	AC110-240V
Width 灯条宽度	25mm三面发光
Power 功率	589w
Luminous Flux 光效	110lm/w
CRI. 显色指数	>80
CCT. 色温	6500K(White)
Life Span 使用寿命	50000H/2 years warranty

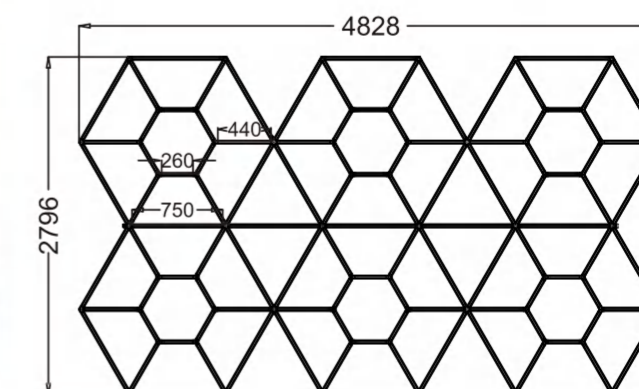

ZT6103



Specification Parameter 规格

Item Code 型号	ZT6103
Space Size 尺寸	5586*2439mm
Voltage 电压	AC110-240V
Width 灯条宽度	25mm三面发光
Power 功率	361w
Luminous Flux 光效	110lm/w
CRI. 显色指数	>80
CCT. 色温	6500K(White)
Life Span 使用寿命	50000H/2 years warranty

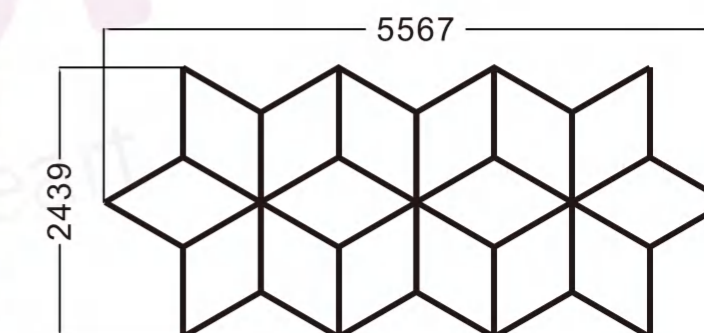

>>> Polygonal Light V6.1

ZT6104

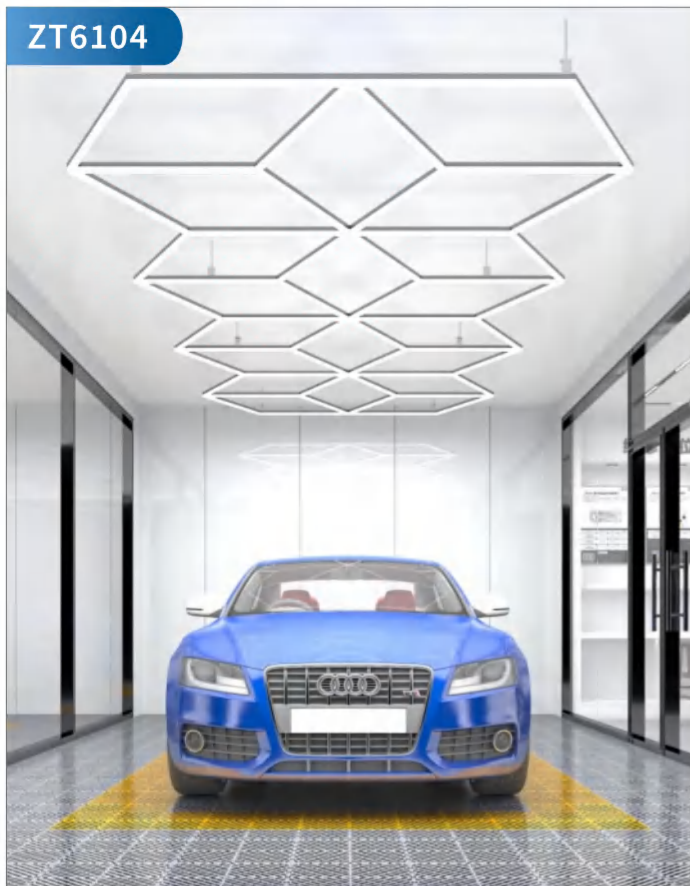

Specification Parameter 规格	
Item Code 型号	ZT6104
Space Size 尺寸	5601*2428mm
Voltage 电压	AC100-240V
Width 灯条宽度	25mm三面发光
Power 功率	430w
Luminous Flux 光效	110lm/w
CRI. 显色指数	>80
CCT. 色温	6500K(White)
Life Span 使用寿命	50000H/2 years warranty

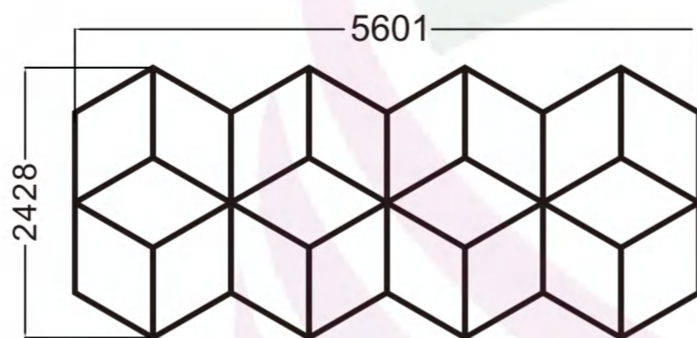

Polygonal Light V6.1 >>>

ZT6106



Specification Parameter 规格	
Item Code 型号	ZT6106
Space Size 尺寸	4828*2796mm
Voltage 电压	AC110-240V
Width 灯条宽度	25mm三面发光
Power 功率	224w
Luminous Flux 光效	110lm/w
CRI. 显色指数	>80
CCT. 色温	6500K(White)
Life Span 使用寿命	50000H/2 years warranty

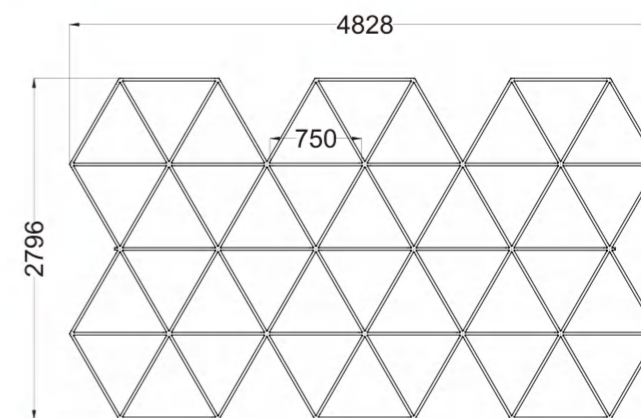

ZT6105



Specification Parameter 规格	
Item Code 型号	ZT6105
Space Size 尺寸	2796*2028mm
Voltage 电压	AC110-240V
Width 灯条宽度	25mm三面发光
Power 功率	361w
Luminous Flux 光效	110lm/w
CRI. 显色指数	>80
CCT. 色温	6500K(White)
Life Span 使用寿命	50000H/2 years warranty

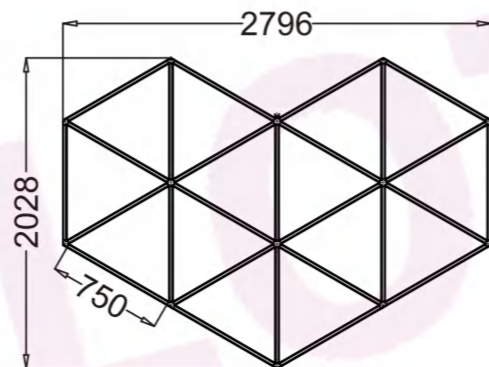

ZT6109

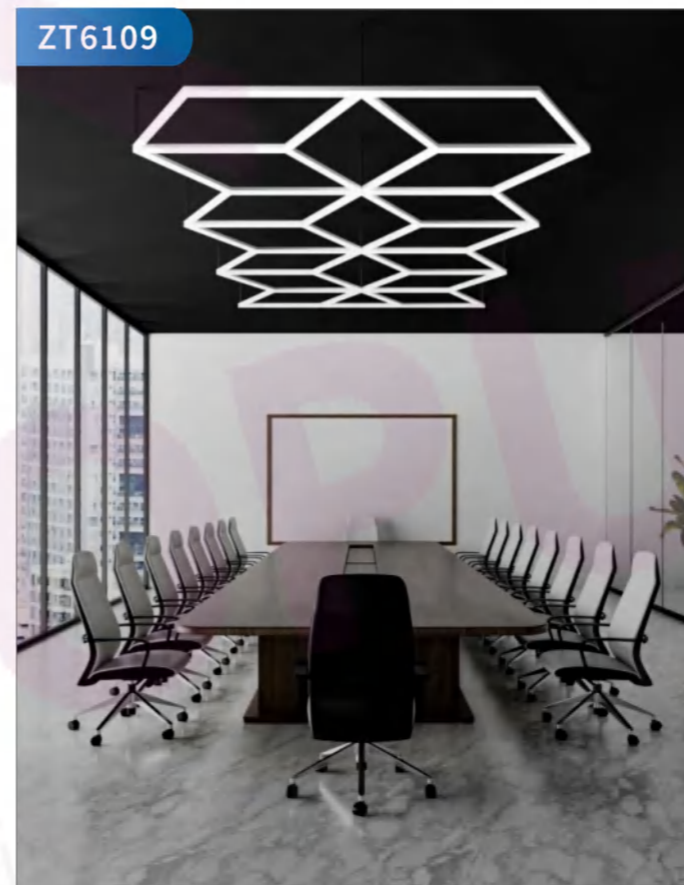

Specification Parameter 规格	
Item Code 型号	ZT6109
Space Size 尺寸	4875*2428mm
Voltage 电压	AC110-240V
Width 灯条宽度	25mm三面发光
Power 功率	387w
Luminous Flux 光效	110lm/w
CRI. 显色指数	>80
CCT. 色温	6500K(White)
Life Span 使用寿命	50000H/2 years warranty

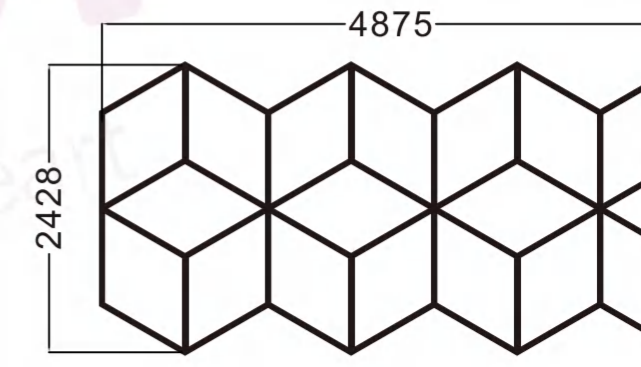

>>> Polygonal Light V6.1

ZT6110

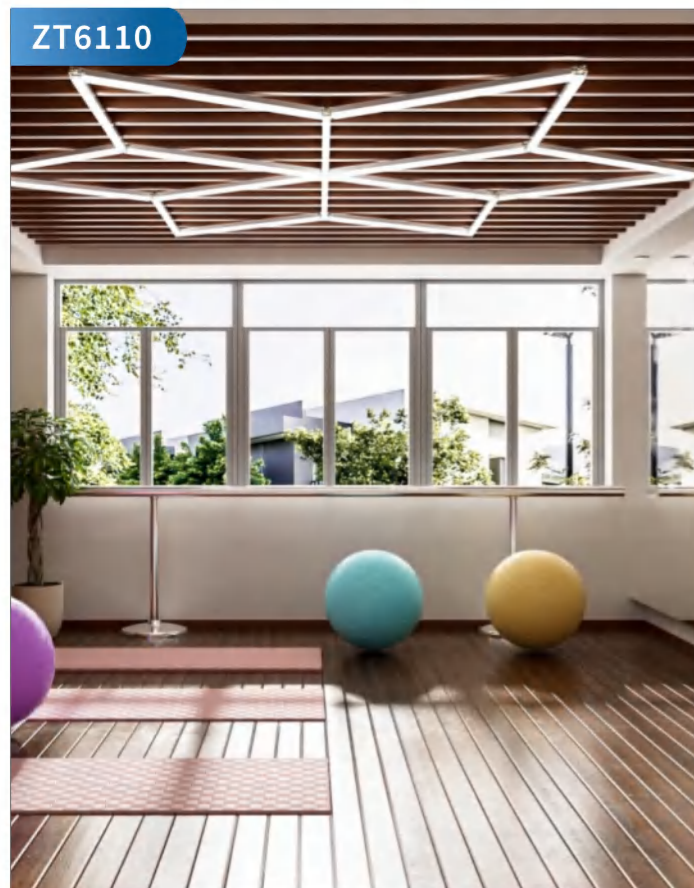

Specification Parameter 规格	
Item Code 型号	ZT6110
Space Size 尺寸	2815*2439mm
Voltage 电压	AC110-240V
Width 灯条宽度	25mm三面发光
Power 功率	155w
Luminous Flux 光效	110lm/w
CRI. 显色指数	>80
CCT. 色温	6500K(White)
Life Span 使用寿命	50000H/2 years warranty

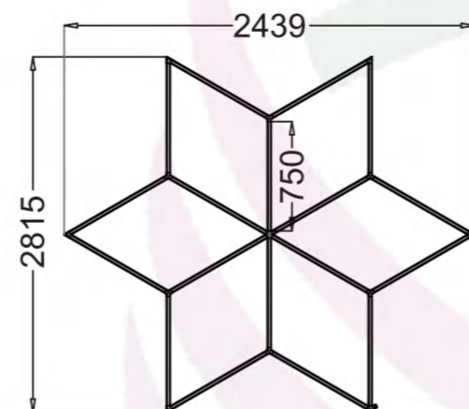

ZT6112

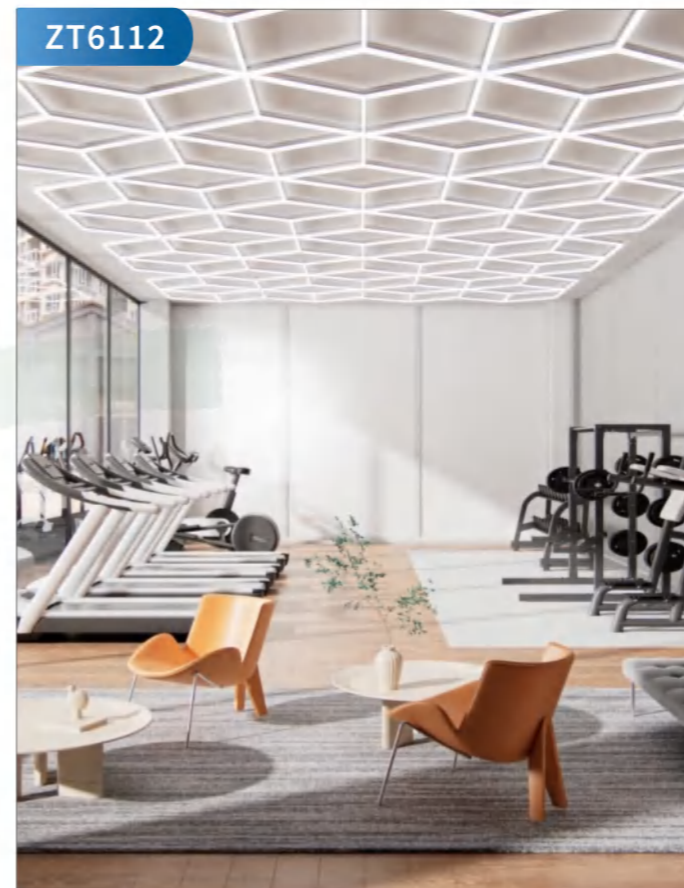

Specification Parameter 规格	
Item Code 型号	ZT6112
Space Size 尺寸	1411*2428mm
Voltage 电压	AC110-240V
Width 灯条宽度	20mm
Power 功率	120W
Luminous Flux 光效	110lm/w
CRI. 显色指数	>90
CCT. 色温	6500K(White)
Life Span 使用寿命	50000H/2 years warranty

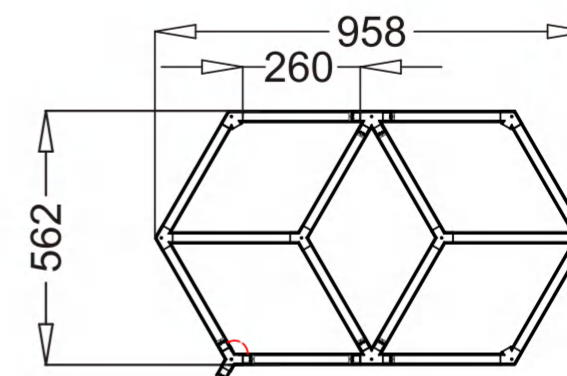

ZT6111



Specification Parameter 规格	
Item Code 型号	ZT6111
Space Size 尺寸	968*1655mm
Voltage 电压	AC110-240V
Width 灯条宽度	25mm三面发光
Power 功率	90w
Luminous Flux 光效	110lm/w
CRI. 显色指数	>80
CCT. 色温	6500K(White)
Life Span 使用寿命	50000H/2 years warranty

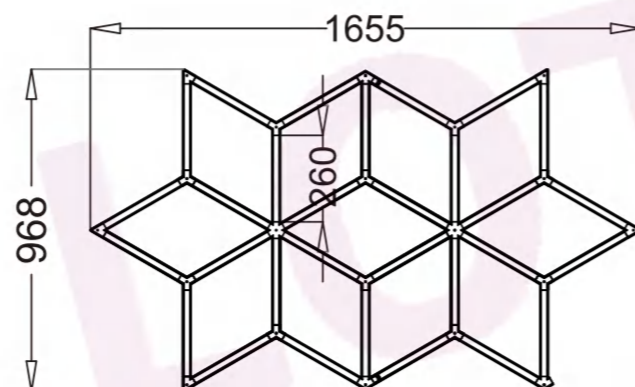

ZT6113



Specification Parameter 规格	
Item Code 型号	ZT6113
Space Size 尺寸	4828*2796mm
Voltage 电压	AC110-240V
Width 灯条宽度	25mm三面发光
Power 功率	447w
Luminous Flux 光效	110lm/w
CRI. 显色指数	>80
CCT. 色温	6500K(White)
Life Span 使用寿命	50000H/2 years warranty

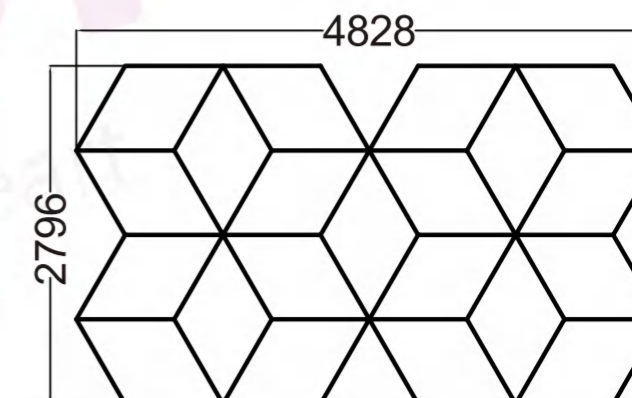

>>> Polygonal Light V6.1

ZT6114



Specification Parameter 规格	
Item Code 型号	ZT6114
Space Size 尺寸	4828*2796mm
Voltage 电压	AC110-240V
Width 灯条宽度	25mm三面发光
Power 功率	413w
Luminous Flux 光效	110lm/w
CRI. 显色指数	>80
CCT. 色温	6500K(White)
Life Span 使用寿命	50000H/2 years warranty

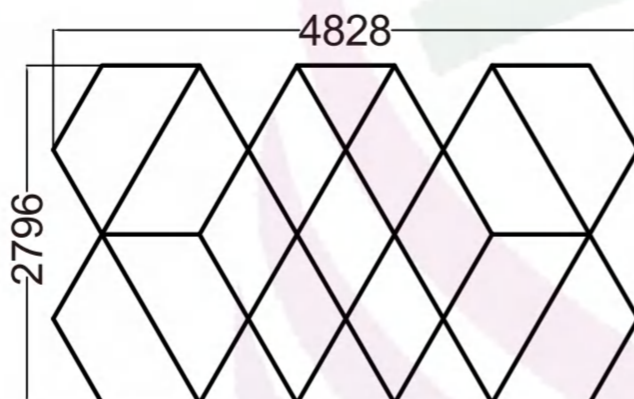

Polygonal Light V6.1 >>>

ZT6116



Specification Parameter 规格	
Item Code 型号	ZT6116
Space Size 尺寸	4828mm*2796mm
Voltage 电压	AC110-240V
Width 灯条宽度	80mm
Power 功率	362W
Luminous Flux 光效	110lm/w
CRI. 显色指数	>90
CCT. 色温	6500K(White)
Life Span 使用寿命	50000H/2 years warranty

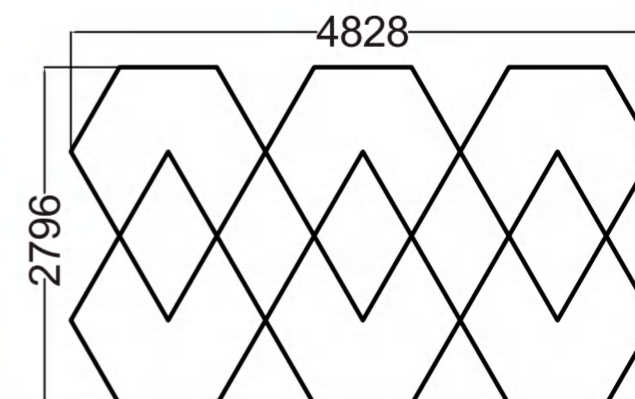

ZT6115



Specification Parameter 规格	
Item Code 型号	ZT6115
Space Size 尺寸	4828*2796mm
Voltage 电压	AC110-240V
Width 灯条宽度	25mm三面发光
Power 功率	413w
Luminous Flux 光效	110lm/w
CRI. 显色指数	>80
CCT. 色温	6500K(White)
Life Span 使用寿命	50000H/2 years warranty

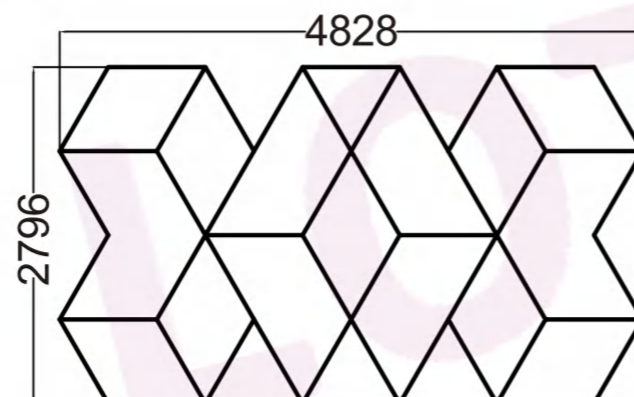

ZT6117

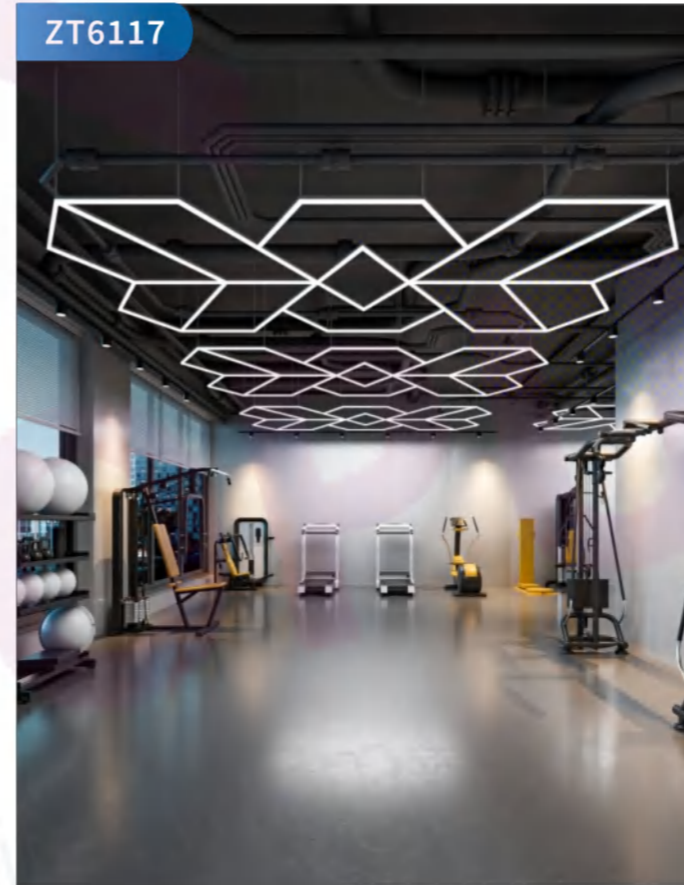

Specification Parameter 规格	
Item Code 型号	ZT6117
Space Size 尺寸	4828*2796mm
Voltage 电压	AC110-240V
Width 灯条宽度	25mm三面发光
Power 功率	387w
Luminous Flux 光效	110lm/w
CRI. 显色指数	>80
CCT. 色温	6500K(White)
Life Span 使用寿命	50000H/2 years warranty

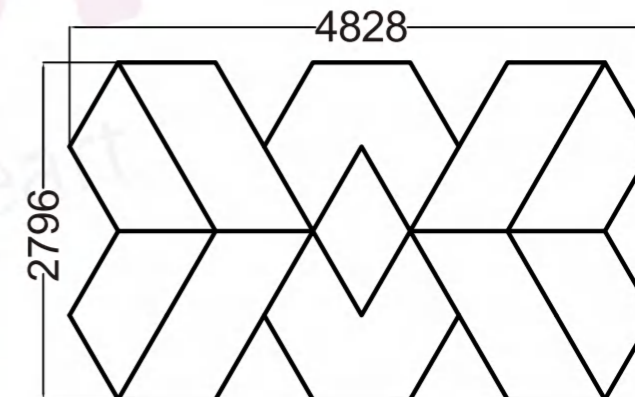

>>> Polygonal Light V6.1

ZT6118



Specification Parameter 规格	
Item Code 型号	ZT6118
Space Size 尺寸	4828mm*2796mm
Voltage 电压	AC100-240V
Width 灯条宽度	25mm三面发光
Power 功率	336W
Luminous Flux 光效	110lm/w
CRI. 显色指数	>80
CCT. 色温	6500K(White)
Life Span 使用寿命	50000H/2 years warranty

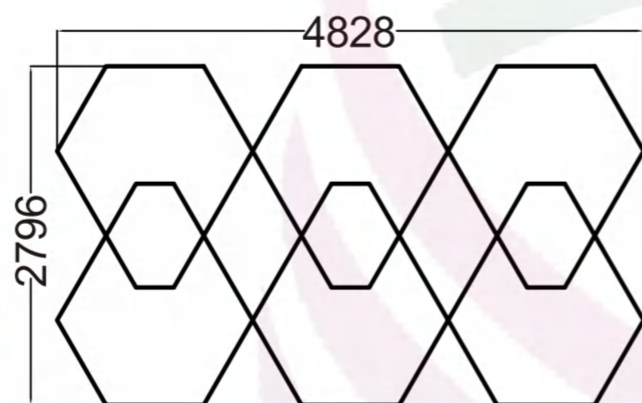

Polygonal Light V6.1 >>>

ZT6120



Specification Parameter 规格	
Item Code 型号	ZT6120
Space Size 尺寸	4828*2796mm
Voltage 电压	AC110-240V
Width 灯条宽度	25mm三面发光
Power 功率	387w
Luminous Flux 光效	110lm/w
CRI. 显色指数	>80
CCT. 色温	6500K(White)
Life Span 使用寿命	50000H/2 years warranty

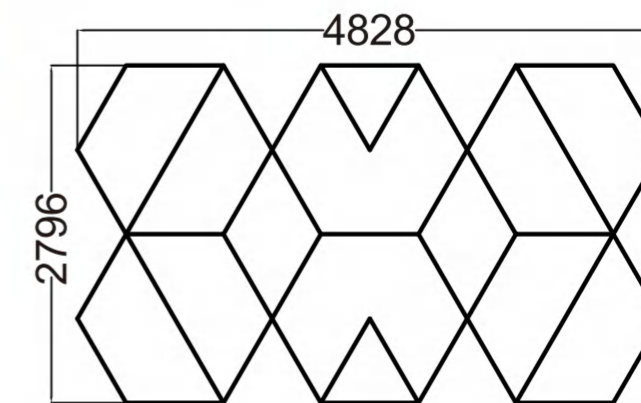

ZT6119



Specification Parameter 规格	
Item Code 型号	ZT6119
Space Size 尺寸	4828*2796mm
Voltage 电压	AC110-240V
Width 灯条宽度	25mm三面发光
Power 功率	379w
Luminous Flux 光效	110lm/w
CRI. 显色指数	>80
CCT. 色温	6500K(White)
Life Span 使用寿命	50000H/2 years warranty

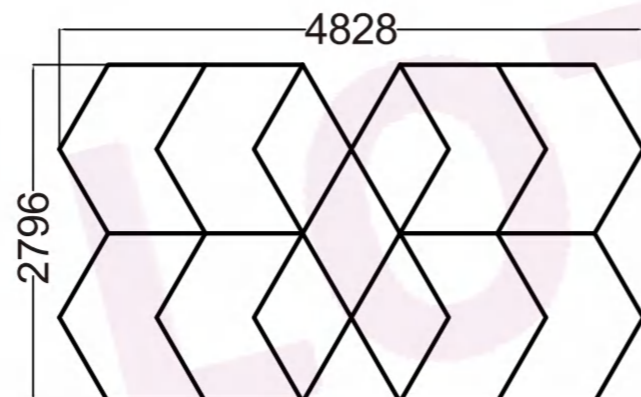

ZT6121



Specification Parameter 规格	
Item Code 型号	ZT6121
Space Size 尺寸	4828*2796mm
Voltage 电压	AC110-240V
Width 灯条宽度	25mm三面发光
Power 功率	396w
Luminous Flux 光效	110lm/w
CRI. 显色指数	>80
CCT. 色温	6500K(White)
Life Span 使用寿命	50000H/2 years warranty

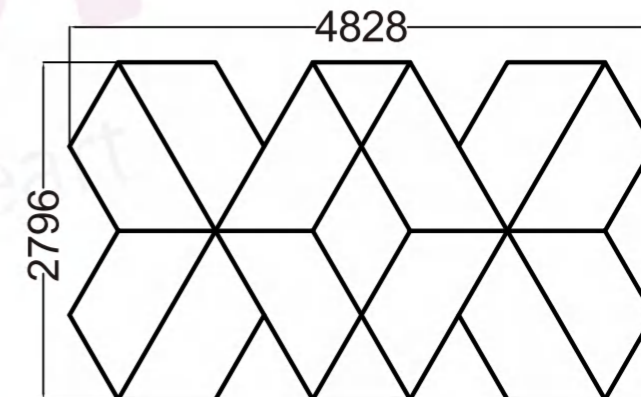

>>> Polygonal Light V6.1

ZT6122



Specification Parameter 规格	
Item Code 型号	ZT6122
Space Size 尺寸	4828*2796mm
Voltage 电压	AC110-240V
Width 灯条宽度	25mm三面发光
Power 功率	405w
Luminous Flux 光效	110lm/w
CRI. 显色指数	>80
CCT. 色温	6500K(White)
Life Span 使用寿命	50000H/2 years warranty

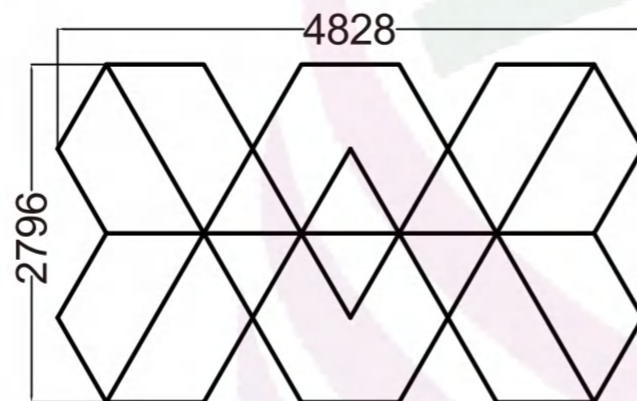

Polygonal Light V6.1 >>>

ZT6124



Specification Parameter 规格	
Item Code 型号	ZT6124
Space Size 尺寸	4828*2796mm
Voltage 电压	AC110-240V
Width 灯条宽度	25mm三面发光
Power 功率	405w
Luminous Flux 光效	110lm/w
CRI. 显色指数	>80
CCT. 色温	6500K(White)
Life Span 使用寿命	50000H/2 years warranty

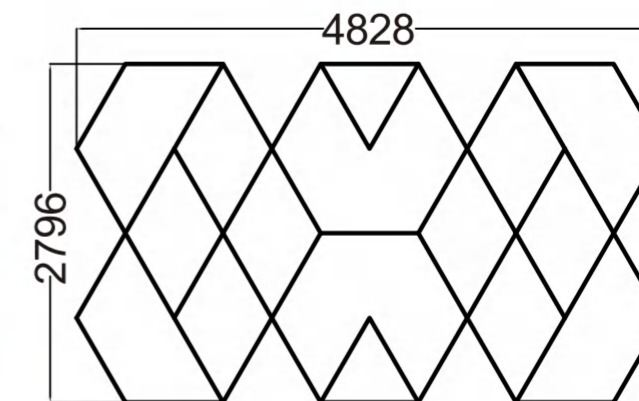

ZT6123



Specification Parameter 规格	
Item Code 型号	ZT6123
Space Size 尺寸	4828*2796mm
Voltage 电压	AC110-240V
Width 灯条宽度	25mm三面发光
Power 功率	405w
Luminous Flux 光效	110lm/w
CRI. 显色指数	>80
CCT. 色温	6500K(White)
Life Span 使用寿命	50000H/2 years warranty

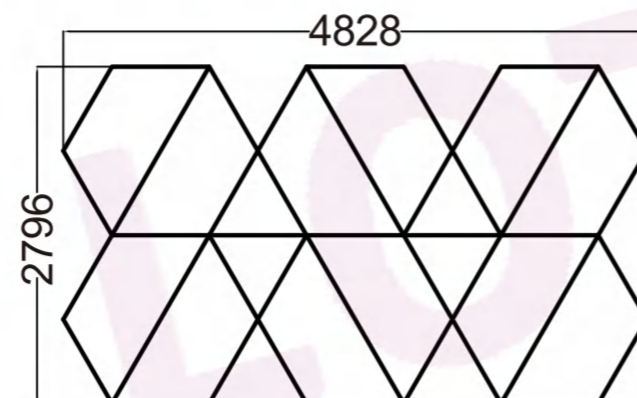

ZT6125

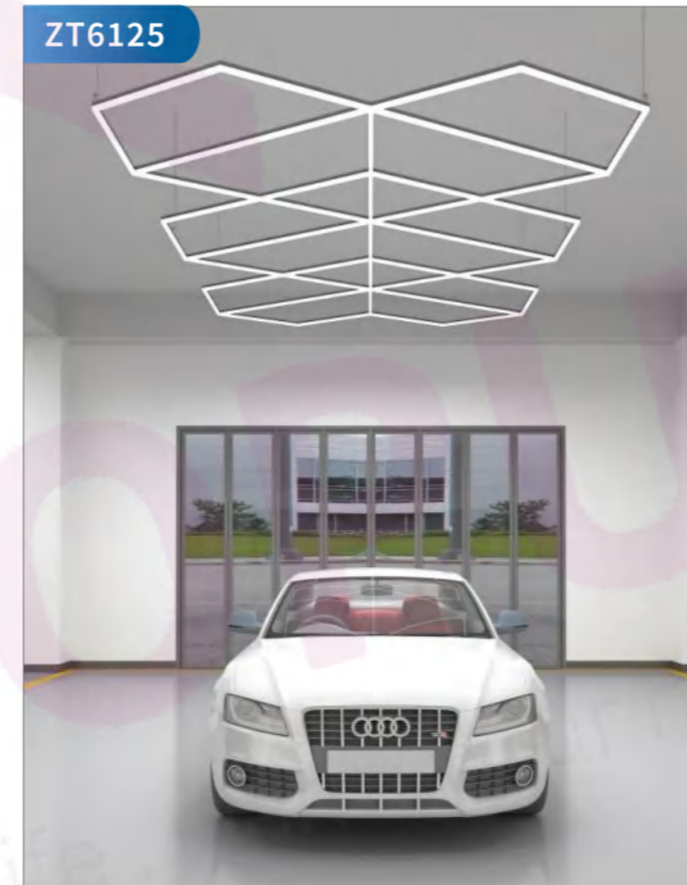

Specification Parameter 规格	
Item Code 型号	ZT6125
Space Size 尺寸	4828*2796mm
Voltage 电压	AC110-240V
Width 灯条宽度	25mm三面发光
Power 功率	405w
Luminous Flux 光效	110lm/w
CRI. 显色指数	>80
CCT. 色温	6500K(White)
Life Span 使用寿命	50000H/2 years warranty

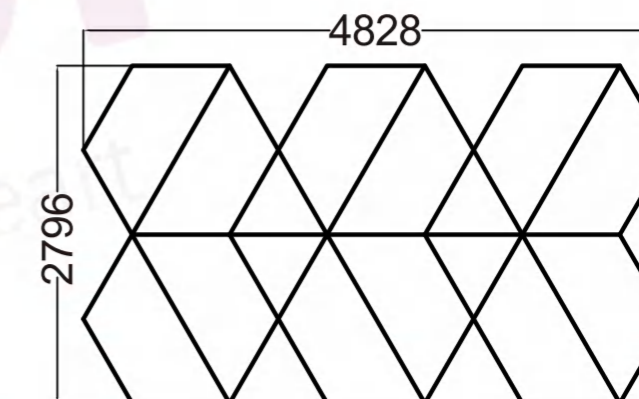

>>> Polygonal Light V6.1

ZT6126



Specification Parameter 规格	
Item Code 型号	ZT6126
Space Size 尺寸	4828*2796mm
Voltage 电压	AC110-240V
Width 灯条宽度	25mm三面发光
Power 功率	413w
Luminous Flux 光效	110lm/w
CRI. 显色指数	>80
CCT. 色温	6500K(White)
Life Span 使用寿命	50000H/2 years warranty

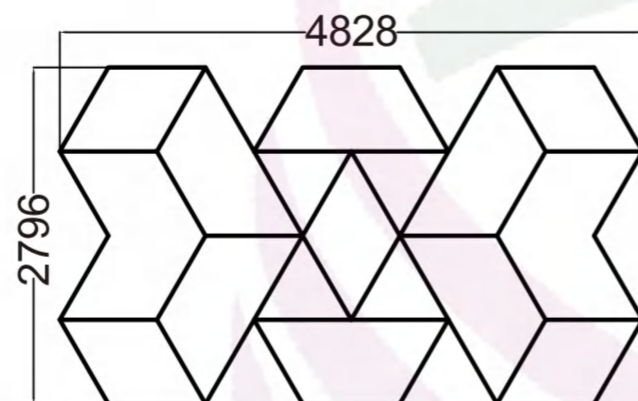

Polygonal Light V6.1 >>>

ZT6128

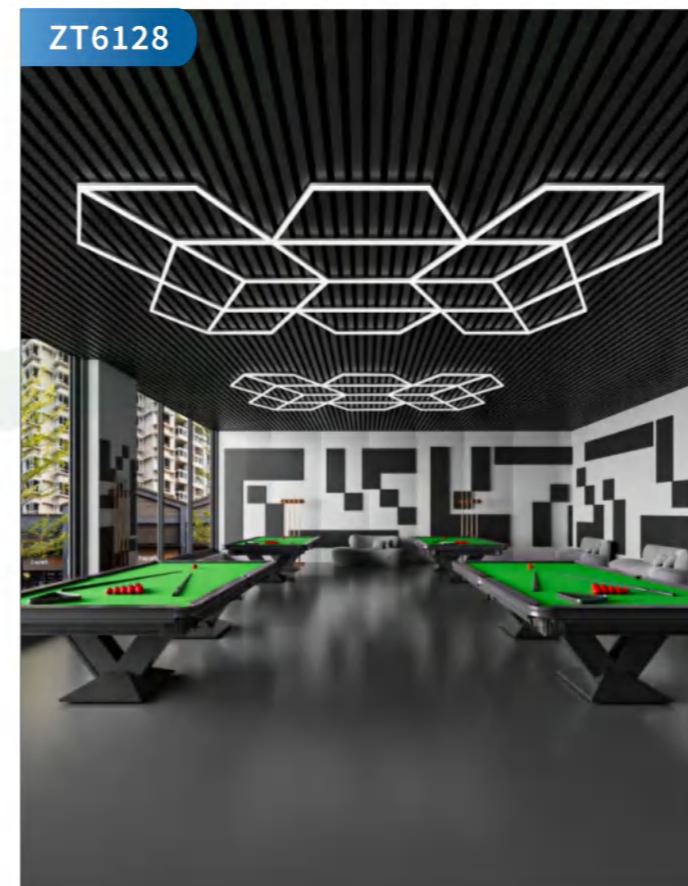

Specification Parameter 规格	
Item Code 型号	ZT6128
Space Size 尺寸	4828*2796mm
Voltage 电压	AC110-240V
Width 灯条宽度	25mm三面发光
Power 功率	421w
Luminous Flux 光效	110lm/w
CRI. 显色指数	>80
CCT. 色温	6500K(White)
Life Span 使用寿命	50000H/2 years warranty

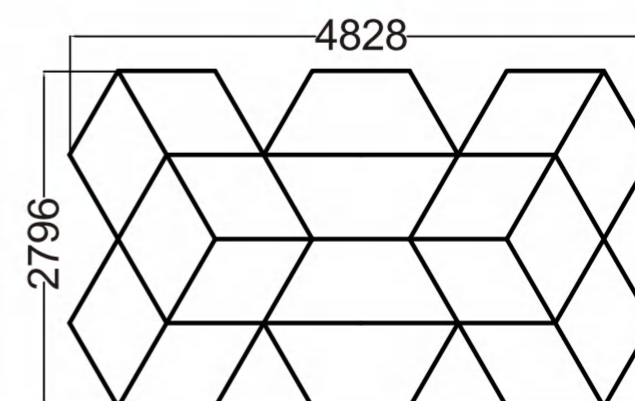

ZT6127



Specification Parameter 规格	
Item Code 型号	ZT6127
Space Size 尺寸	4828*2796mm
Voltage 电压	AC110-240V
Width 灯条宽度	25mm三面发光
Power 功率	387w
Luminous Flux 光效	110lm/w
CRI. 显色指数	>80
CCT. 色温	6500K(White)
Life Span 使用寿命	50000H/2 years warranty

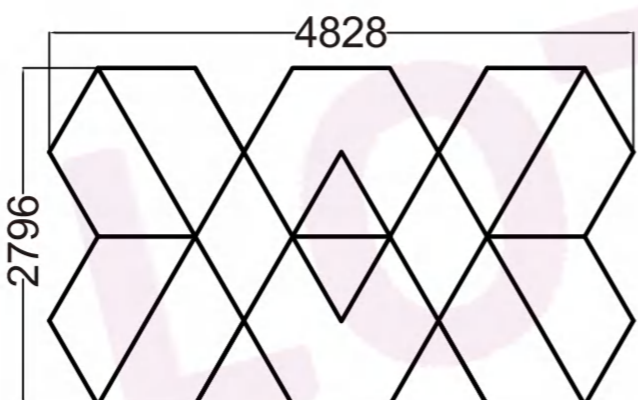

ZT6129



Specification Parameter 规格	
Item Code 型号	ZT6129
Space Size 尺寸	4828*2796mm
Voltage 电压	AC110-240V
Width 灯条宽度	25mm三面发光
Power 功率	421w
Luminous Flux 光效	110lm/w
CRI. 显色指数	>80
CCT. 色温	6500K(White)
Life Span 使用寿命	50000H/2 years warranty

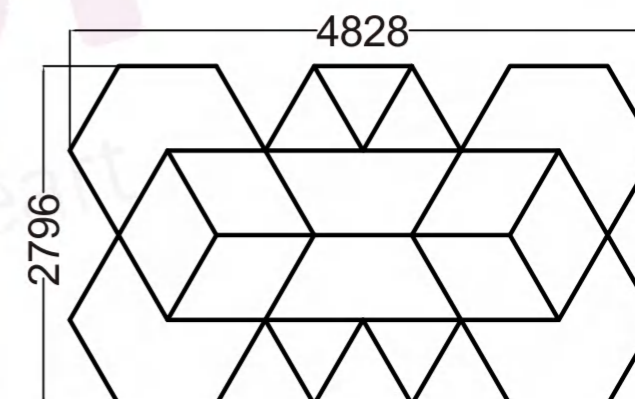

>>> Polygonal Light V6.1



ZT6130

Specification Parameter 规格	
Item Code 型号	ZT6130
Space Size 尺寸	4828*2796mm
Voltage 电压	AC110-240V
Width 灯条宽度	25mm三面发光
Power 功率	447w
Luminous Flux 光效	110lm/w
CRI. 显色指数	>80
CCT. 色温	6500K(White)
Life Span 使用寿命	50000H/2 years warranty

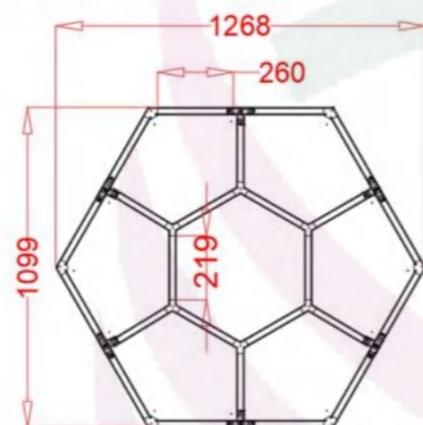

ZT6132

Specification Parameter 规格	
Item Code 型号	ZT6132
Space Size 尺寸	4828*2796mm
Voltage 电压	AC110-240V
Width 灯条宽度	25mm三面发光
Power 功率	284w
Luminous Flux 光效	110lm/w
CRI. 显色指数	>80
CCT. 色温	6500K(White)
Life Span 使用寿命	50000H/2 years warranty

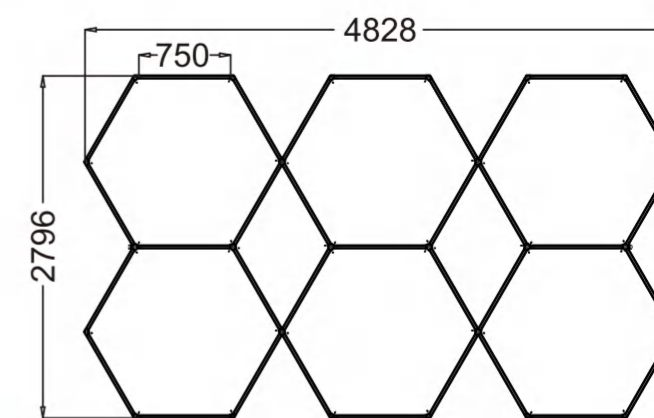

ZT6131

Specification Parameter 规格	
Item Code 型号	ZT6131
Space Size 尺寸	4828*2796mm
Voltage 电压	AC110-240V
Width 灯条宽度	25mm三面发光
Power 功率	602w
Luminous Flux 光效	110lm/w
CRI. 显色指数	>80
CCT. 色温	6500K(White)
Life Span 使用寿命	50000H/2 years warranty

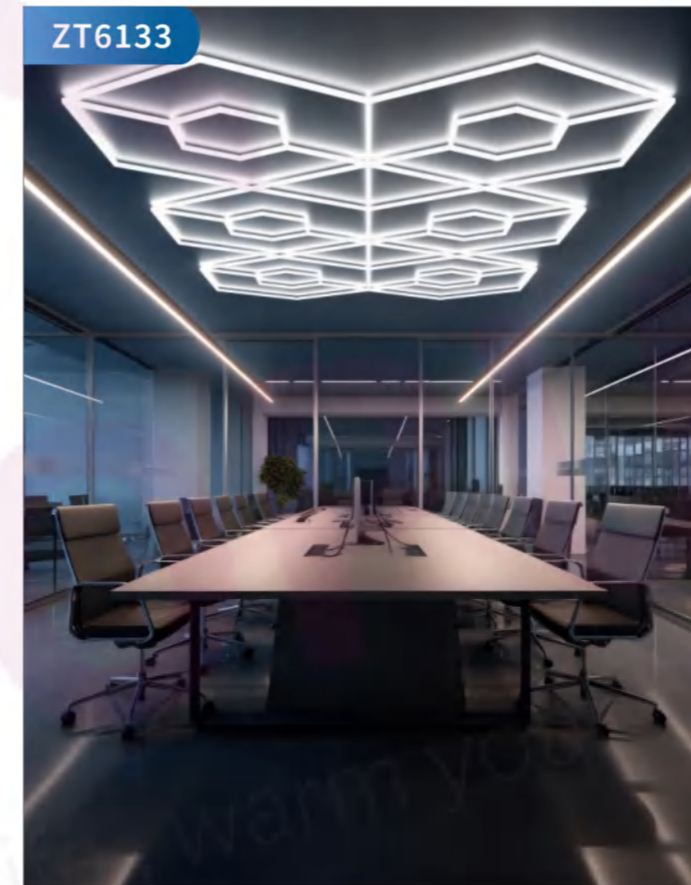
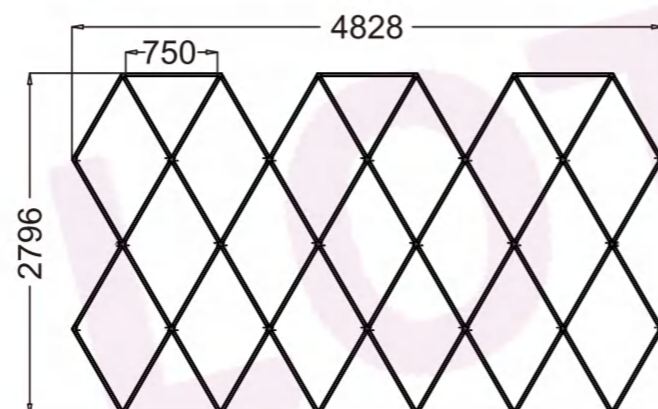

ZT6133

Specification Parameter 规格	
Item Code 型号	ZT6133
Space Size 尺寸	4828*2796mm
Voltage 电压	AC110-240V
Width 灯条宽度	25mm三面发光
Power 功率	469w
Luminous Flux 光效	110lm/w
CRI. 显色指数	>80
CCT. 色温	6500K(White)
Life Span 使用寿命	50000H/2 years warranty

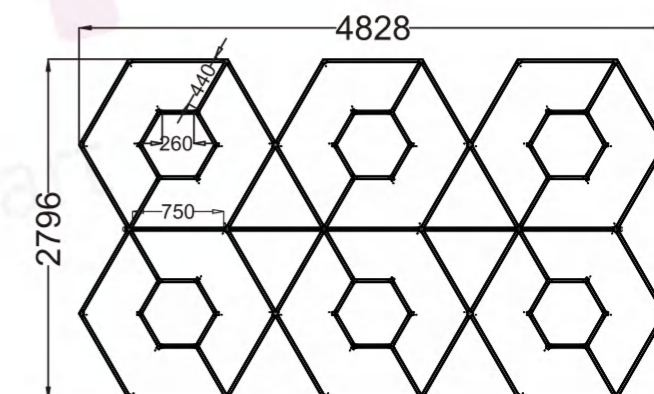

>>> Polygonal Light V6.1



ZT6134

Specification Parameter 规格	
Item Code 型号	ZT6134
Space Size 尺寸	4828*2796mm
Voltage 电压	AC110-240V
Width 灯条宽度	25mm三面发光
Power 功率	572w
Luminous Flux 光效	110lm/w
CRI. 显色指数	>80
CCT. 色温	6500K(White)
Life Span 使用寿命	50000H/2 years warranty

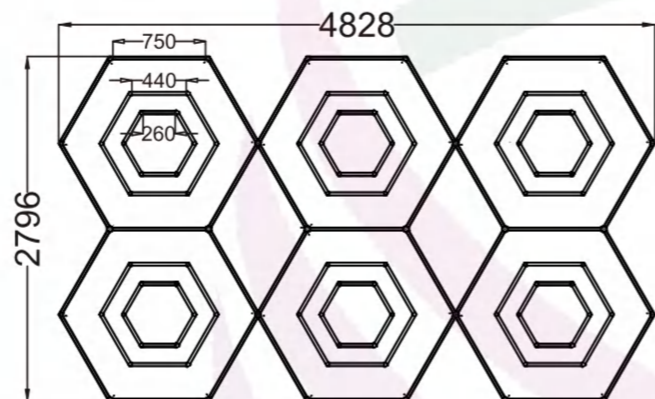

Polygonal Light V6.1 >>>



ZT6136

Specification Parameter 规格	
Item Code 型号	ZT6136
Space Size 尺寸	4899*2365mm
Voltage 电压	AC110-240V
Width 灯条宽度	25mm三面发光
Power 功率	335w
Luminous Flux 光效	110lm/w
CRI. 显色指数	>80
CCT. 色温	6500K(White)
Life Span 使用寿命	50000H/2 years warranty

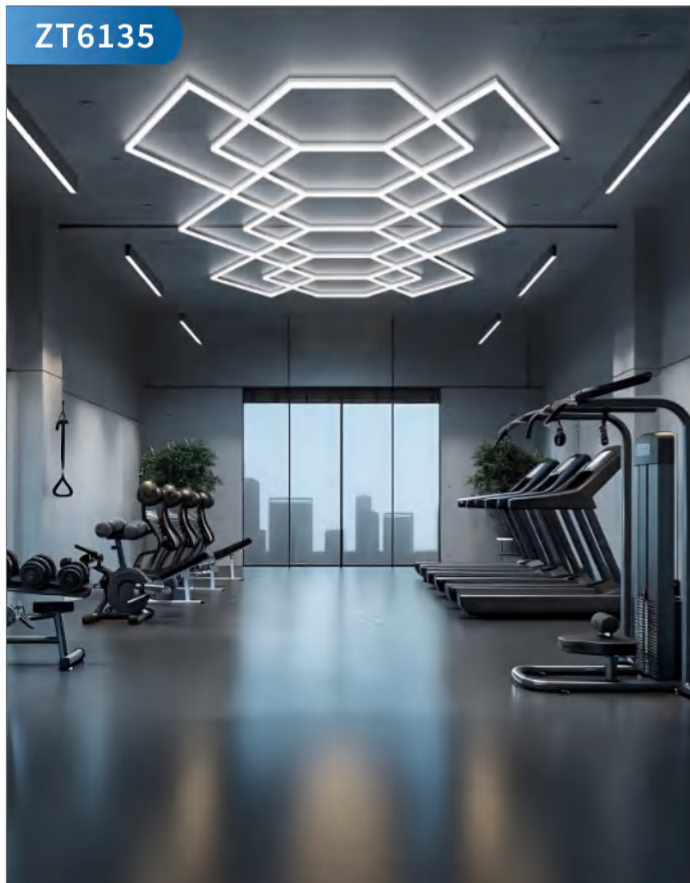
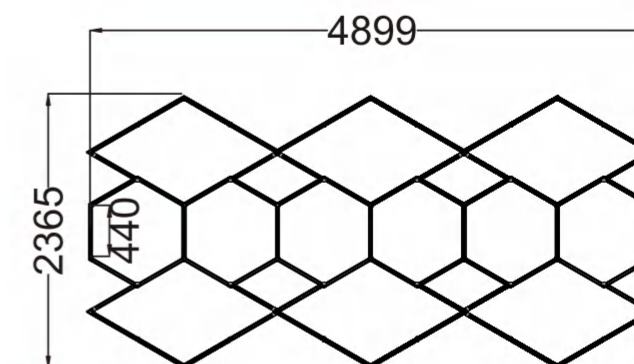

ZT6135

Specification Parameter 规格	
Item Code 型号	ZT6135
Space Size 尺寸	4899*2365mm
Voltage 电压	AC110-240V
Width 灯条宽度	25mm三面发光
Power 功率	395w
Luminous Flux 光效	110lm/w
CRI. 显色指数	>80
CCT. 色温	6500K(White)
Life Span 使用寿命	50000H/2 years warranty

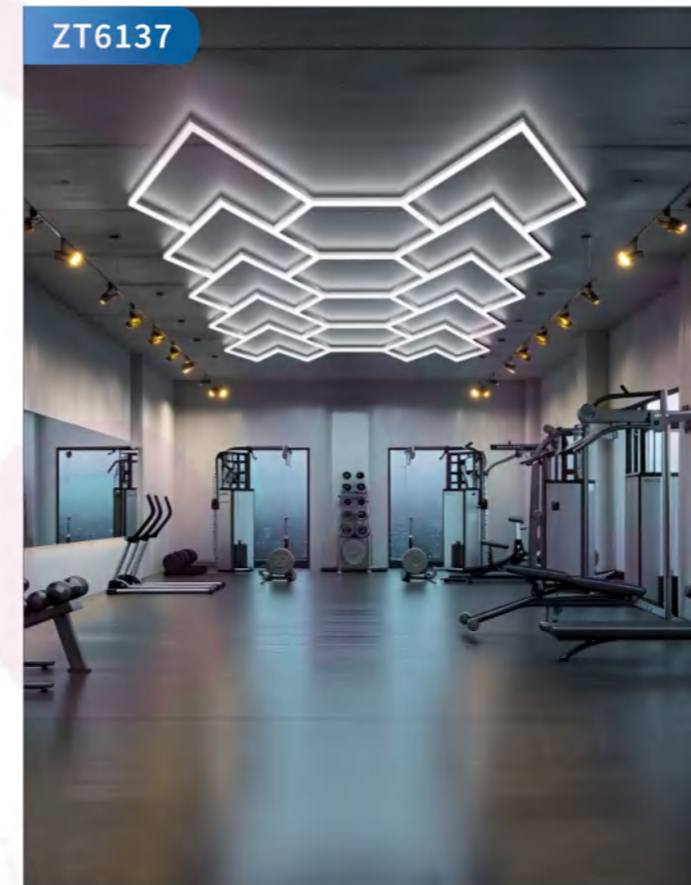
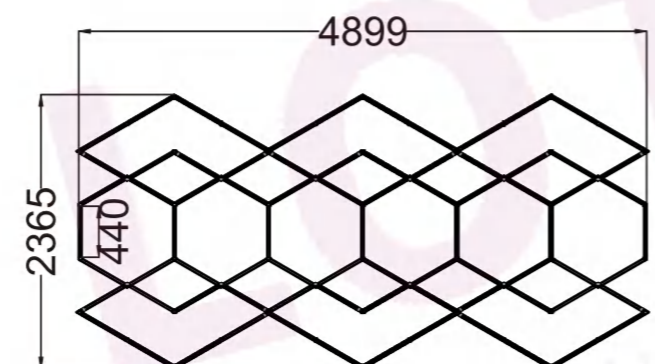

ZT6137

Specification Parameter 规格	
Item Code 型号	ZT6137
Space Size 尺寸	2365*4512mm
Voltage 电压	AC110-240V
Width 灯条宽度	25mm三面发光
Power 功率	447w
Luminous Flux 光效	110lm/w
CRI. 显色指数	>80
CCT. 色温	6500K(White)
Life Span 使用寿命	50000H/2 years warranty

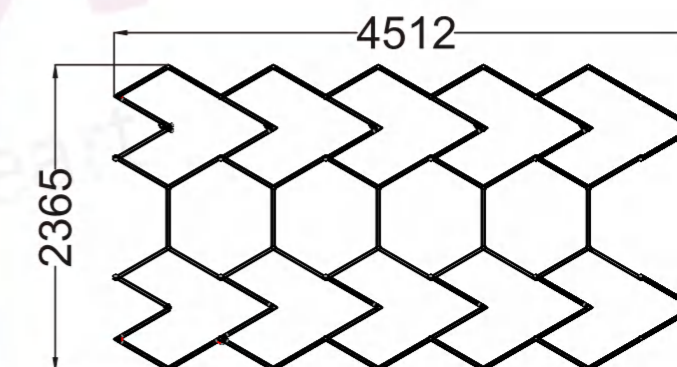



Polygonal Light 多边形灯系列

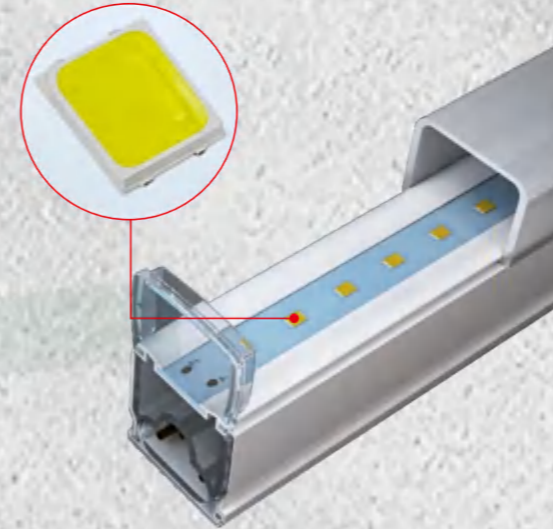

high illumination, reach to 140Lm/W, high color rendering index Ra>85
anti-glare and no flicker

采用进口芯片, 高照度, 高亮度, 单灯珠140Lm/w。
比传统灯具节能60%, 漆面照射无影, 无眩光, 无频闪, 高显指光的还原度达到96%以上。

Fireproof PC, High transparency. 3pins, more stable for the structure, and grounding wire design more safe, one-step connection, copper pins, good for wiring

灯具拼接采用快插接电方式
自动卡位无需手接, 安装一步到位, 快捷方便, 连接头升级改造成三孔, 带地线连接, 更安全稳定。
高透PC面罩设计, 光效更均匀。

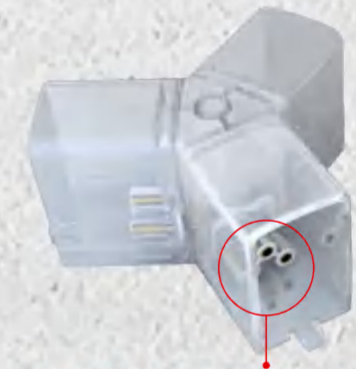

三角形公母头对插设计, 结构稳固, 带地线连接, 达到国标用电标准, 更安全



Thickened aluminum, good for heat dissipation and not easy to get damaged
Anti-glare design, and thickened material to make it stable.

灯体采用加厚铝合金材质, 高效散热, 有效保护灯体使用寿命, 同时外壳更稳定, 不易变形。

Designed by Gonengo, according to the LED circuit

高能自主设计恒流恒压电源, 完美结合灯板内部线路配置。





Specification 规格参数	
Model 型号	ZT/C202
Size 整灯尺寸	600mm
Voltage 电压	AC100-240V
Width 发光面	20mm
Power 功率	8W/6W
Luminous Flux 光通量	110-120lm/w
CRI 显示指数	>90
CCT. 色温	6500K(White)
Lifespan 使用寿命	50000H/2-years warranty

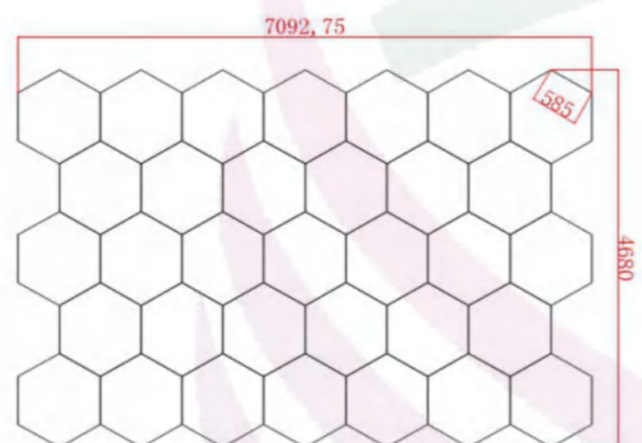

Specification 规格参数	
Model 型号	ZT6028
Size 整灯尺寸	2433mm*4840mm
Voltage 电压	AC100-240V
Width 发光面	20mm
Power 功率	534W
Luminous Flux 光通量	110-120lm/w
CRI 显示指数	>90
CCT. 色温	6500K(White)
Lifespan 使用寿命	50000H/2-years warranty

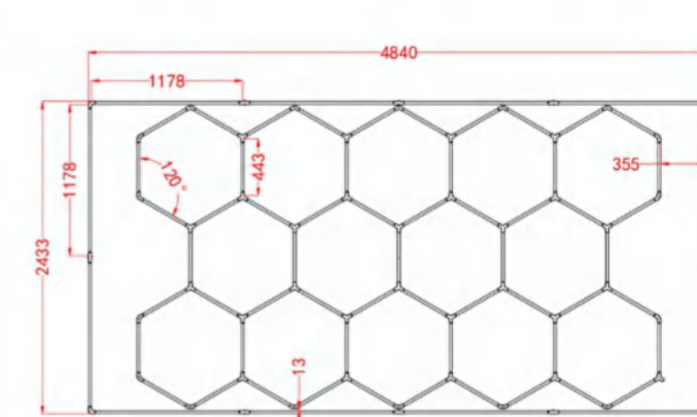

Specification 规格参数	
Model 型号	ZT1018
Size 整灯尺寸	2433mm/4840mm
Voltage 电压	AC100-240V
Width 发光面	20mm
Power 功率	456W
Luminous Flux 光通量	110-120lm/w
CRI 显示指数	>90
CCT. 色温	6500K(White)
Lifespan 使用寿命	50000H/2-years warranty

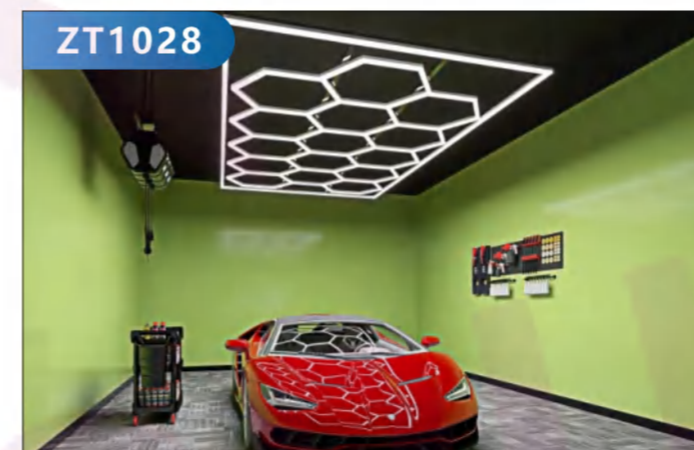
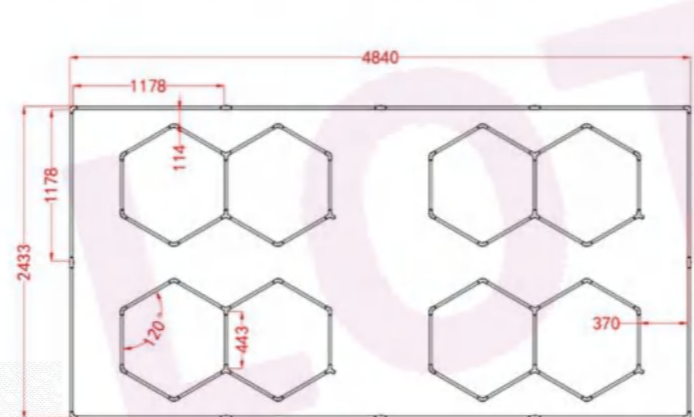

Specification 规格参数	
Model 型号	ZT1028
Size 整灯尺寸	2433mm*4840mm
Voltage 电压	AC100-240V
Width 发光面	20mm
Power 功率	552W
Luminous Flux 光通量	110-120lm/w
CRI 显示指数	>90
CCT. 色温	6500K(White)
Lifespan 使用寿命	50000H/2-years warranty

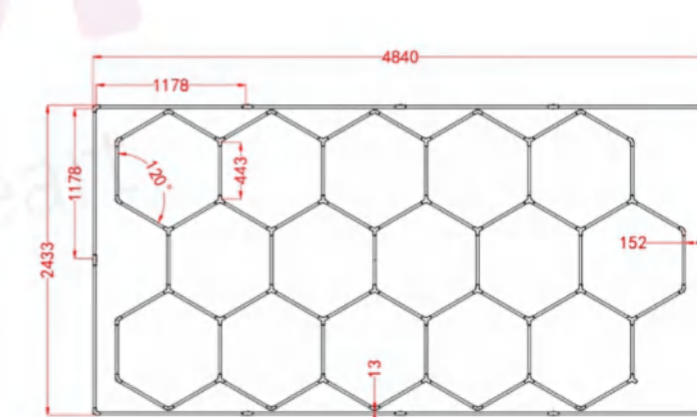
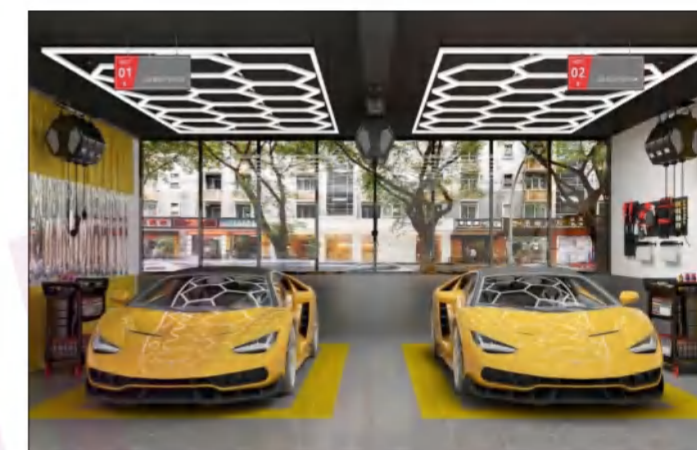

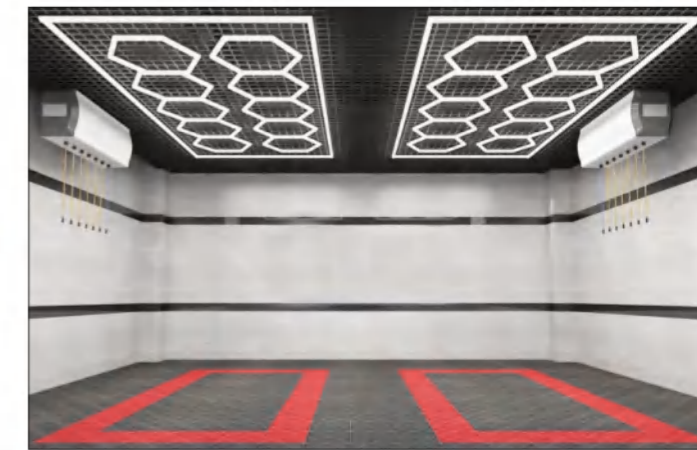
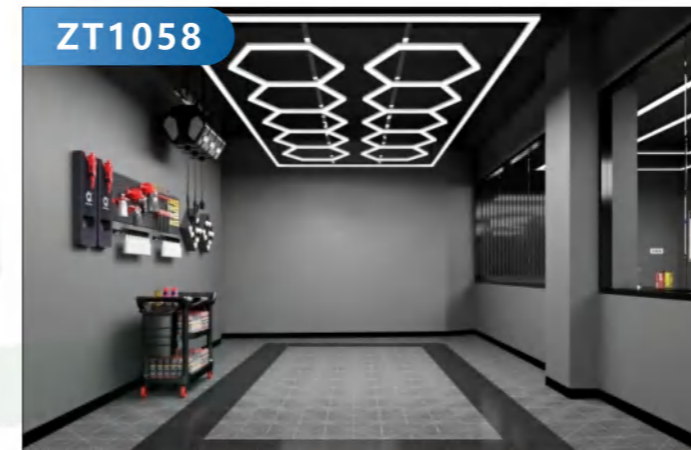
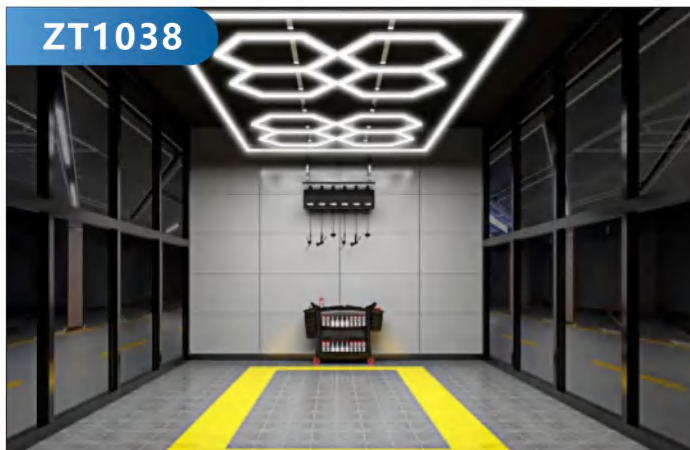

Specification 规格参数	
Model 型号	ZT1038
Size 整灯尺寸	2433mm*4840mm
Voltage 电压	AC100-240V
Width 发光面	20mm
Power 功率	456W
Luminous Flux 光通量	110-120lm/w
CRI 显示指数	>90
CCT. 色温	6500K(White)
Lifespan 使用寿命	50000H/2-years warranty

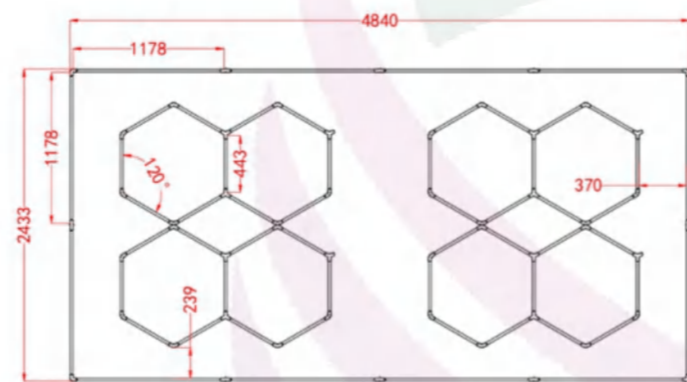

Specification 规格参数	
Model 型号	ZT1058
Size 整灯尺寸	2433mm*4840mm
Voltage 电压	AC100-240V
Width 发光面	20mm
Power 功率	504W
Luminous Flux 光通量	110-120lm/w
CRI 显示指数	>90
CCT. 色温	6500K(White)
Lifespan 使用寿命	50000H/2-years warranty

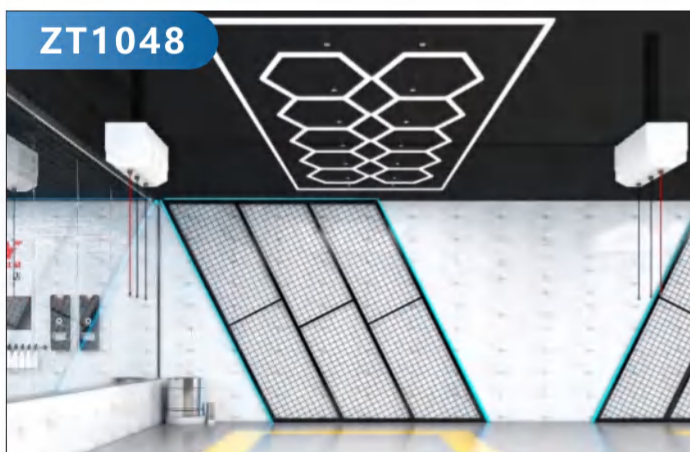
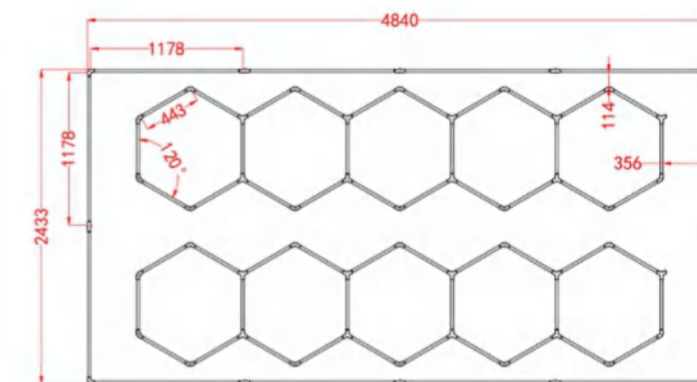

Specification 规格参数	
Model 型号	ZT1048
Size 整灯尺寸	2433mm*840mm
Voltage 电压	AC100-240V
Width 发光面	20mm
Power 功率	504W
Luminous Flux 光通量	110-120lm/w
CRI 显示指数	>90
CCT. 色温	6500K(White)
Lifespan 使用寿命	50000H/2-years warranty

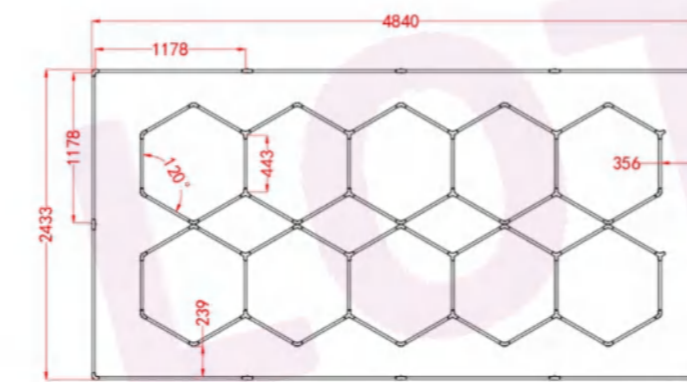

Specification 规格参数	
Model 型号	ZT1068
Size 整灯尺寸	2433mm*4840mm
Voltage 电压	AC220V
Width 发光面	20mm
Power 功率	504W
Luminous Flux 光通量	110-120lm/w
CRI 显示指数	>90
CCT. 色温	6500K(White)
Lifespan 使用寿命	50000H/2-years warranty

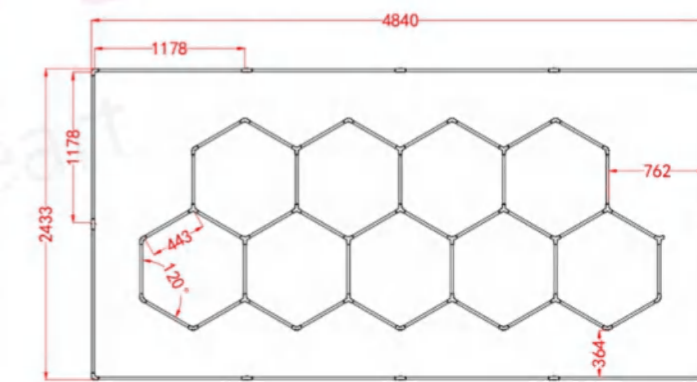

>>> Polygonal Light V3.0

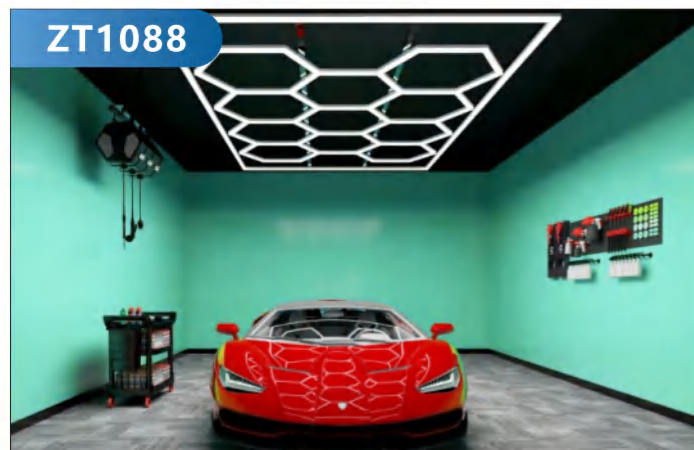

Specification 规格参数	
Model 型号	ZT1088
Size 整灯尺寸	3025mm*4780mm
Voltage 电压	AC100-240V
Width 发光面	20mm
Power 功率	576W
Luminous Flux 光通量	110-120lm/w
CRI 显示指数	>90
CCT. 色温	6500K(White)
Lifespan 使用寿命	50000H/2-years warranty

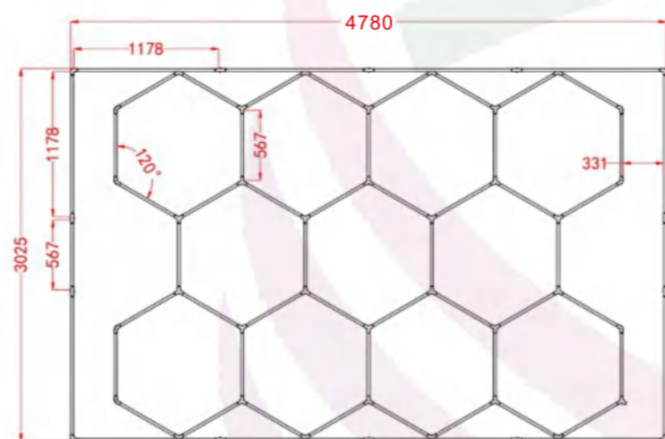

Polygonal Light V3.0 >>>



Specification 规格参数	
Model 型号	ZT2018
Size 整灯尺寸	2433mm*4840mm
Voltage 电压	AC100-240V
Width 发光面	20mm
Power 功率	512W
Luminous Flux 光通量	110-120lm/w
CRI 显示指数	>90
CCT. 色温	6500K(White)
Lifespan 使用寿命	50000H/2-years warranty

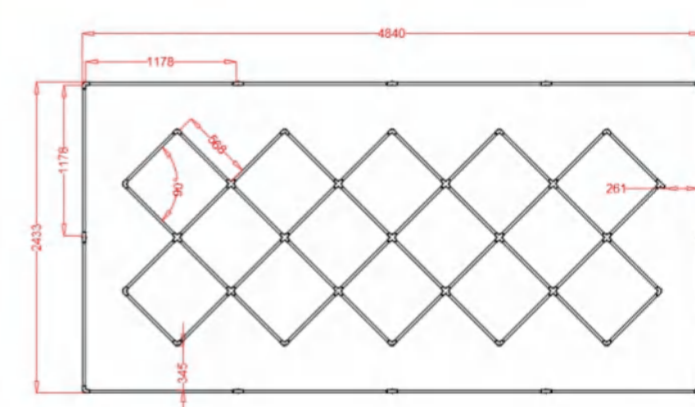
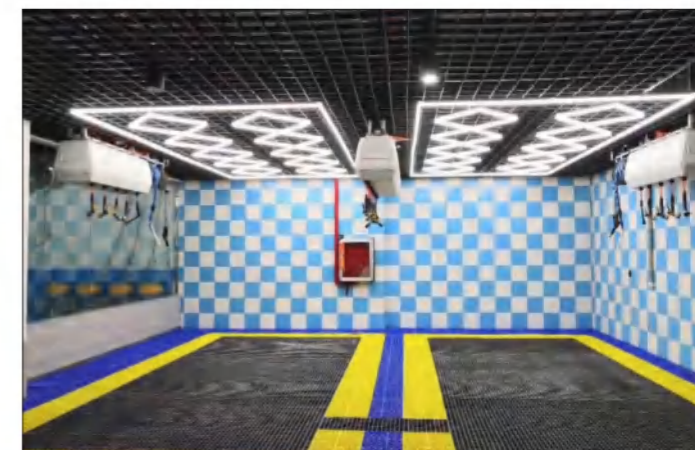

Specification 规格参数	
Model 型号	ZT/C203
Size 整灯尺寸	600mm
Voltage 电压	AC100-240V
Width 发光面	20mm
Power 功率	8W/0.6M
Luminous Flux 光通量	110-120lm/w
CRI 显示指数	>90
CCT. 色温	6500K(White)
Lifespan 使用寿命	50000H/2-years warranty

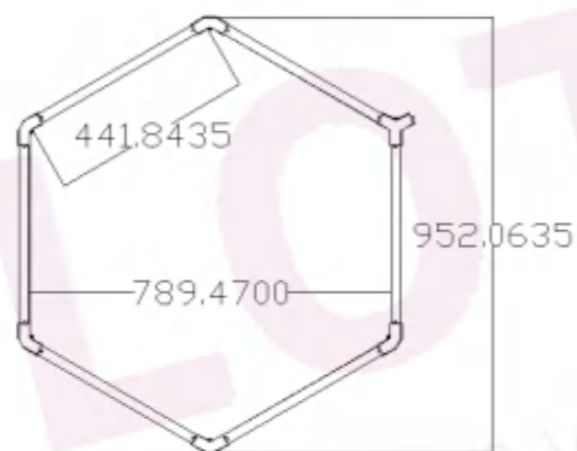

Specification 规格参数	
Model 型号	ZT2028
Size 整灯尺寸	2433mm*4840mm
Voltage 电压	AC100-240V
Width 发光面	20mm
Power 功率	448W
Luminous Flux 光通量	110-120lm/w
CRI 显示指数	>90
CCT. 色温	6500K(White)
Lifespan 使用寿命	50000H/2-years warranty

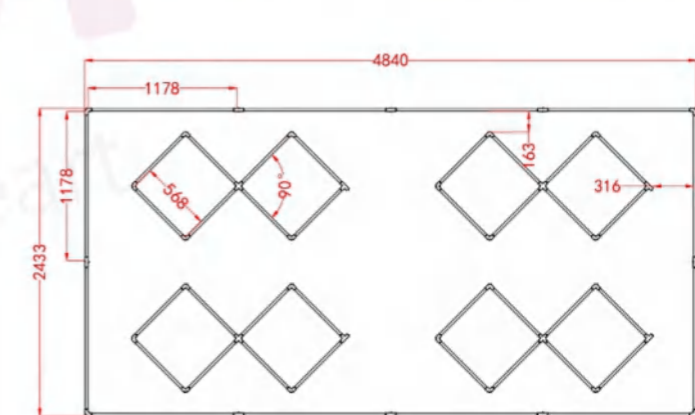

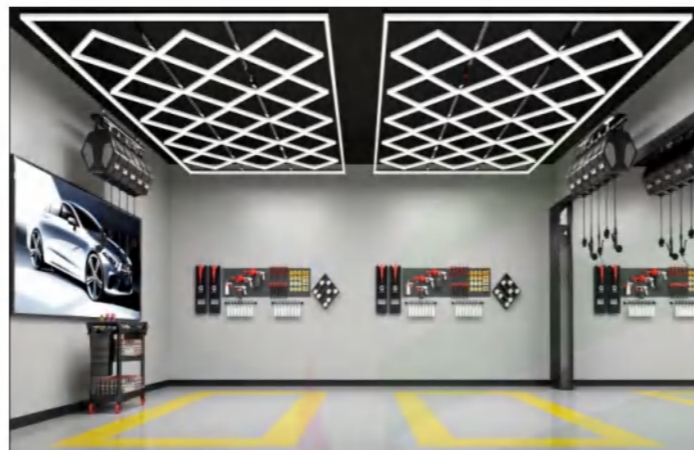

Specification 规格参数	
Model 型号	ZT2038
Size 整灯尺寸	2834mm*4840mm
Voltage 电压	AC100-220V
Width 发光面	20mm
Power 功率	680W
Luminous Flux 光通量	110-120lm/w
CRI 显示指数	>90
CCT. 色温	6500K(White)
Lifespan 使用寿命	50000H/2-years warranty

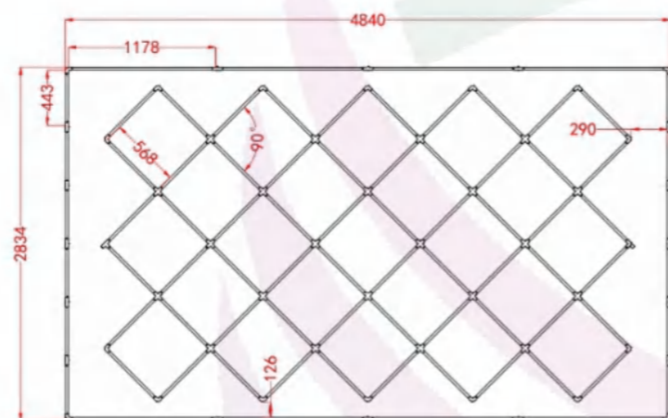

Specification 规格参数	
Model 型号	ZT2078
Size 整灯尺寸	2433mm*4840mm
Voltage 电压	AC100-240V
Width 发光面	20mm
Power 功率	288W
Luminous Flux 光通量	110-120lm/w
CRI 显示指数	>90
CCT. 色温	6500K(White)
Lifespan 使用寿命	50000H/2-years warranty

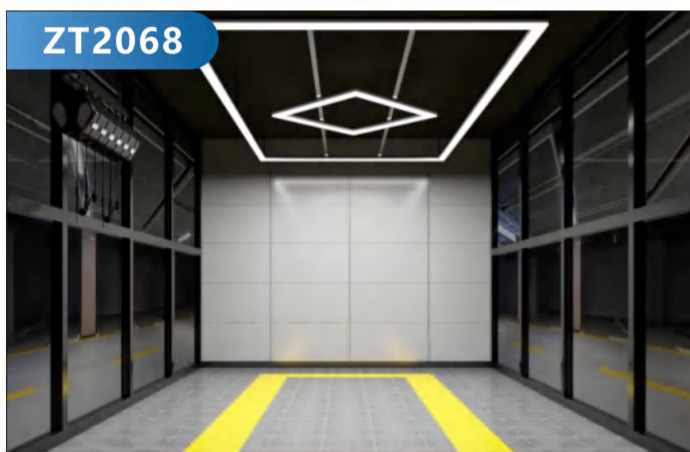
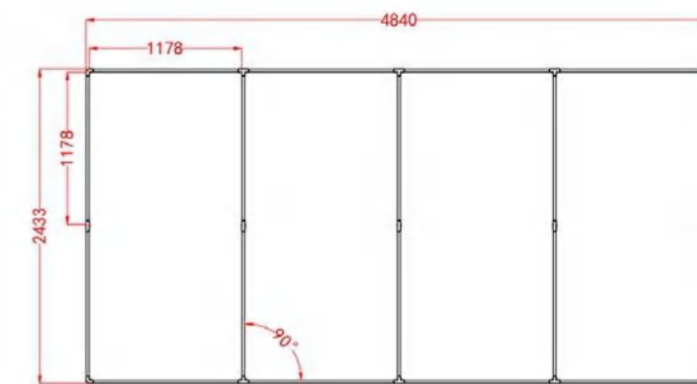

Specification 规格参数	
Model 型号	ZT2068
Size 整灯尺寸	2433mm*4840mm
Voltage 电压	AC100-220V
Width 发光面	20mm
Power 功率	256W
Luminous Flux 光通量	110-120lm/w
CRI 显示指数	>90
CCT. 色温	6500K(White)
Lifespan 使用寿命	50000H/2-years warranty

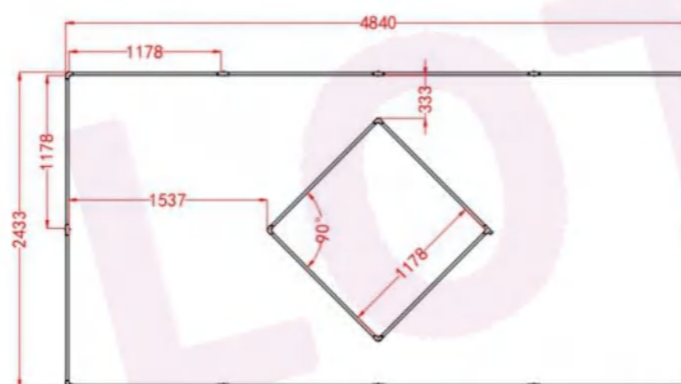

Specification 规格参数	
Model 型号	ZT2088
Size 整灯尺寸	2433mm*4840mm
Voltage 电压	AC100-220V
Width 发光面	20mm
Power 功率	384W
Luminous Flux 光通量	110-120lm/w
CRI 显示指数	>90
CCT. 色温	6500K(White)
Lifespan 使用寿命	50000H/2-years warranty

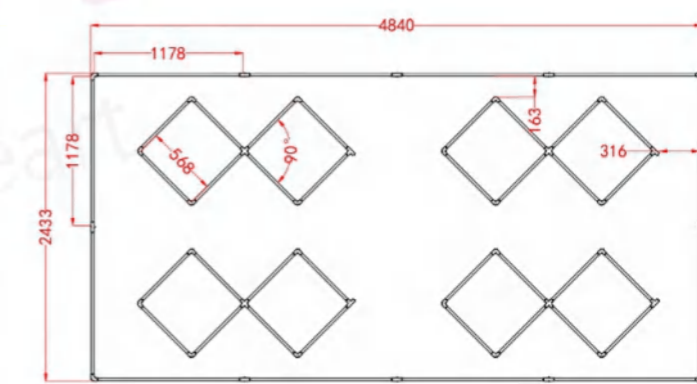



Specification 规格参数	
Model 型号	ZT3018
Size 整灯尺寸	2834mm*4840mm
Voltage 电压	AC100-220V
Width 发光面	20mm
Power 功率	384W
Luminous Flux 光通量	110-120lm/w
CRI 显示指数	>90
CCT. 色温	6500K(White)
Lifespan 使用寿命	50000H/2-years warranty

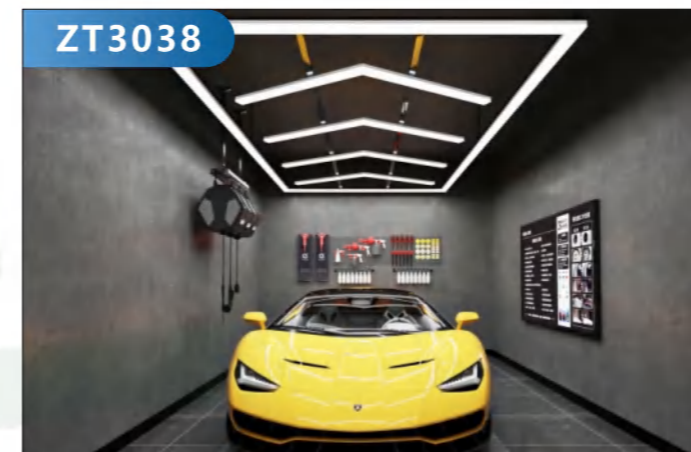
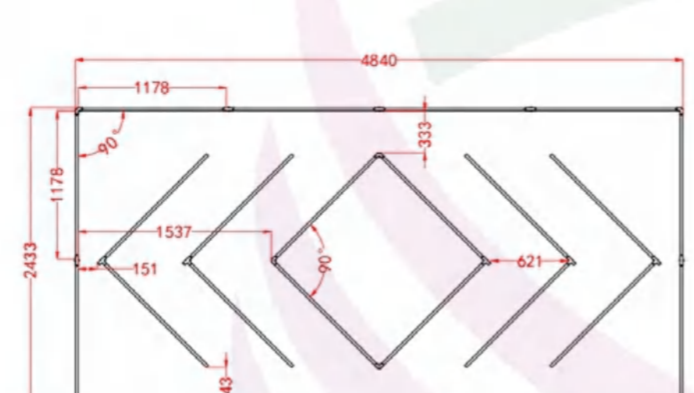

Specification 规格参数	
Model 型号	ZT3038
Size 整灯尺寸	2433mm*4840mm
Voltage 电压	AC100-240V
Width 发光面	20mm
Power 功率	384W
Luminous Flux 光通量	110-120lm/w
CRI 显示指数	>90
CCT. 色温	6500K(White)
Lifespan 使用寿命	50000H/2-years warranty

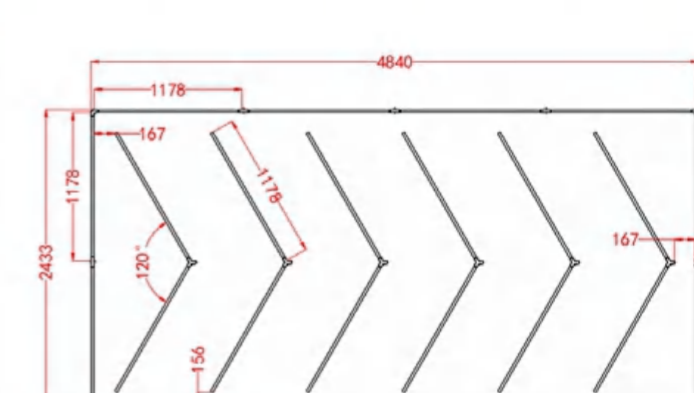

Specification 规格参数	
Model 型号	ZT3028
Size 整灯尺寸	2433mm*4840mm
Voltage 电压	AC100-240V
Width 发光面	20mm
Power 功率	384W
Luminous Flux 光通量	110-120lm/w
CRI 显示指数	>90
CCT. 色温	6500K(White)
Lifespan 使用寿命	50000H/2-years warranty

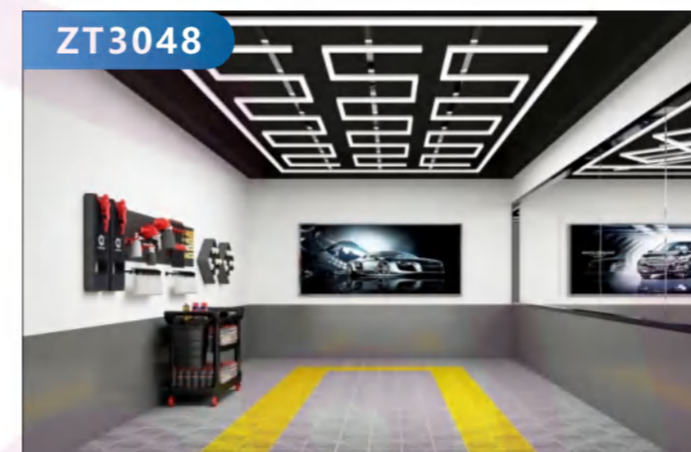
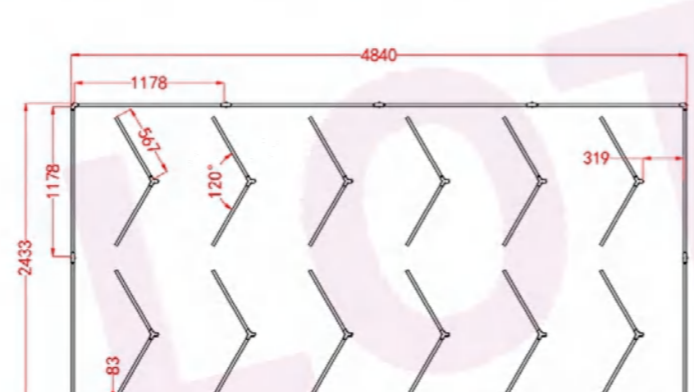

Specification 规格参数	
Model 型号	ZT3048
Size 整灯尺寸	2433mm*4840mm
Voltage 电压	AC100-240V
Width 发光面	20mm
Power 功率	552W
Luminous Flux 光通量	110-120lm/w
CRI 显示指数	>90
CCT. 色温	6500K(White)
Lifespan 使用寿命	50000H/2-years warranty

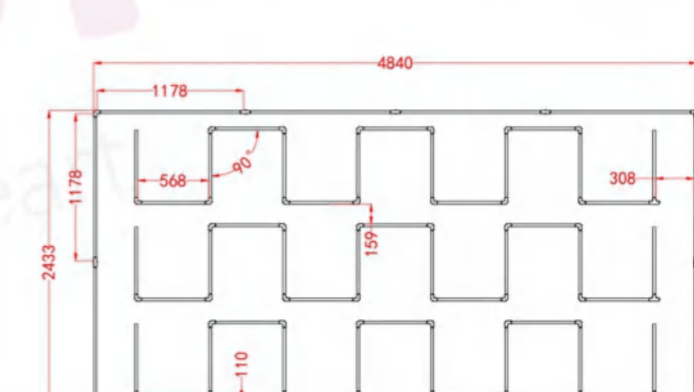
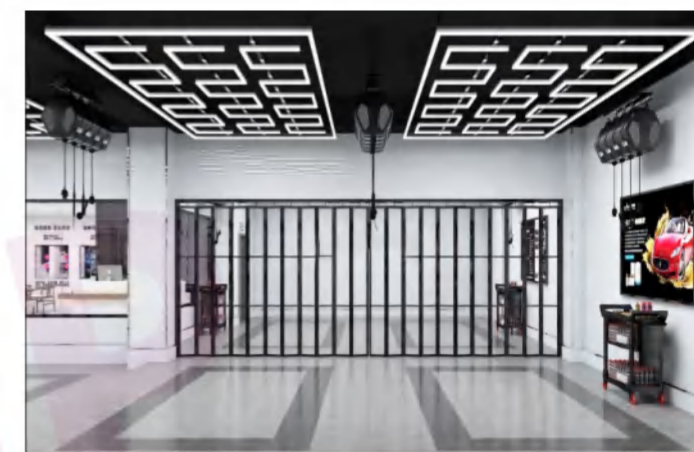

>>> Polygonal Light V3.1

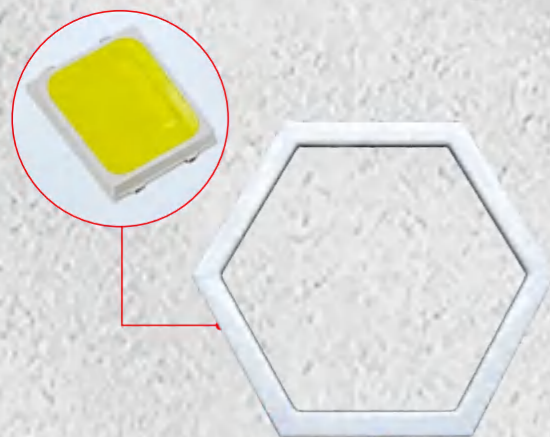

DIY assemble partern.
High illumination, reach to 120Lm/W, high color rendering index Ra>80, anti-glare and no flicker

外形采用DIY拼装设计。
采用进口芯片, 高照度, 高亮度, 单灯珠120Lm/w。
比传统灯具节能60%, 漆面照射无影, 无眩光, 无频闪, 高显指光的还原度达到80%以上。

Fireproof PC cover, High transparency.
DC24V design more safe, and satisfied to the international standard.

高透防火PC面罩设计, 光效更均匀。
DC24伏低压配置, 更安全, 符合多项国际标准。



Thickened aluminum, good for heat dissipation and not easy to get damaged
Anti-glare design, and thickened material to make it stable.

灯体采用加厚铝合金材质, 高效散热, 有效保护灯体使用寿命, 同时外壳更稳定, 不易变形。

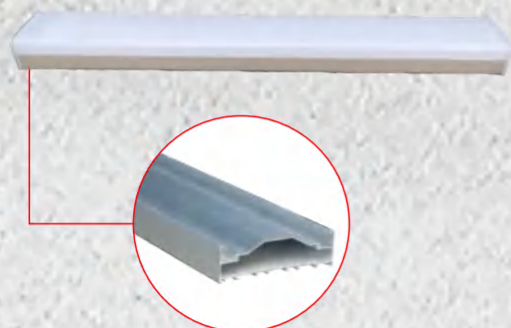

Designed by Gonengo, according to the LED circuit

高能自主设计恒流恒压电源, 完美结合灯板内部线路配置。



Polygonal Light V3.1 >>>



Specification 规格参数	
Model 型号	ZTC503
Size 整灯尺寸	997mm*1152mm
Voltage 电压	AC100-240V
Width 发光面	80mm
Power 功率	102W
Luminous Flux 光通量	110-120lm/w
CRI 显示指数	>90
CCT. 色温	6500K(White)
Lifespan 使用寿命	50000H/2-years warranty

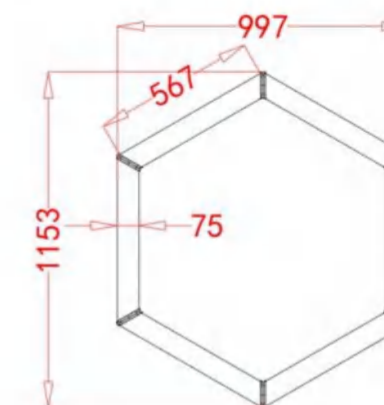

Specification 规格参数	
Model 型号	ZTC505
Size 整灯尺寸	1178mm*2069mm
Voltage 电压	AC100-240V
Width 发光面	80mm
Power 功率	163W
Luminous Flux 光通量	110-120lm/w
CRI 显示指数	>90
CCT. 色温	6500K(White)
Lifespan 使用寿命	50000H/2-years warranty

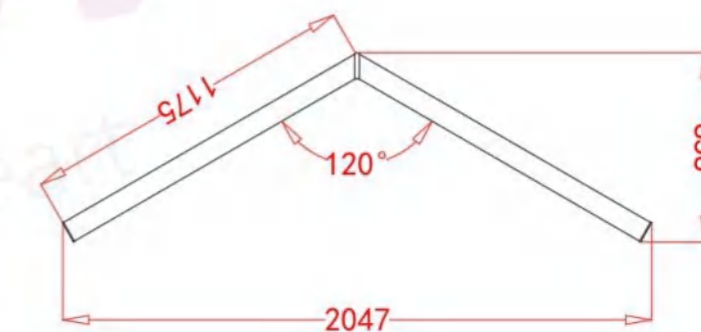

>>> Polygonal Light V3.1



Specification 规格参数	
Model 型号	ZT5018
Size 整灯尺寸	2543mm*4897mm
Voltage 电压	AC100-240V
Width 发光面	80mm
Power 功率	725W
Luminous Flux 光通量	110-120lm/w
CRI 显示指数	>90
CCT. 色温	6500K(White)
Lifespan 使用寿命	50000H/2-years warranty

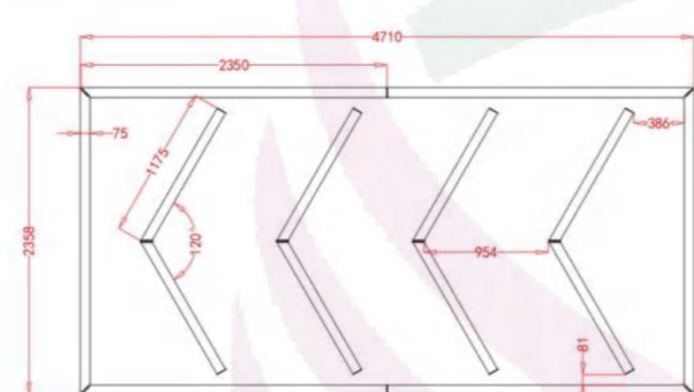

Specification 规格参数	
Model 型号	ZT5058
Size 整灯尺寸	2358mm*4710mm
Voltage 电压	AC100-240V
Width 发光面	80mm
Power 功率	745W
Luminous Flux 光通量	110-120lm/w
CRI 显示指数	>90
CCT. 色温	6500K(White)
Lifespan 使用寿命	50000H/2-years warranty

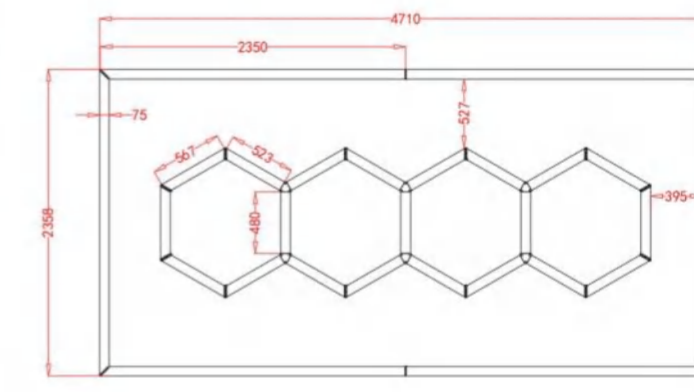
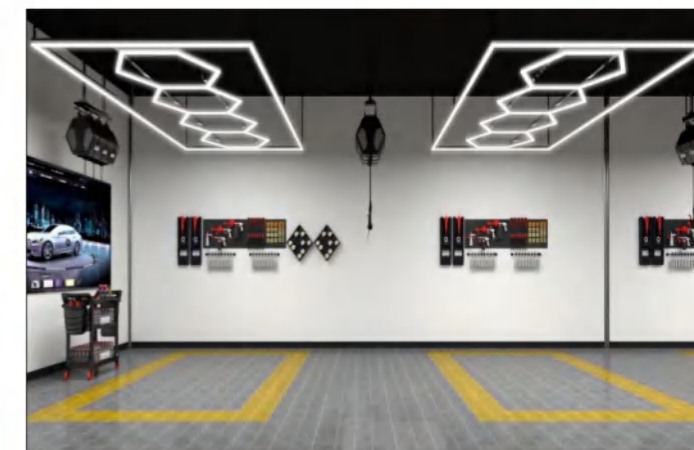

Specification 规格参数	
Model 型号	ZT5028
Size 整灯尺寸	2361mm*4714mm
Voltage 电压	AC100-240V
Width 发光面	80mm
Power 功率	886W
Luminous Flux 光通量	110-120lm/w
CRI 显示指数	>90
CCT. 色温	6500K(White)
Lifespan 使用寿命	50000H/2-years warranty

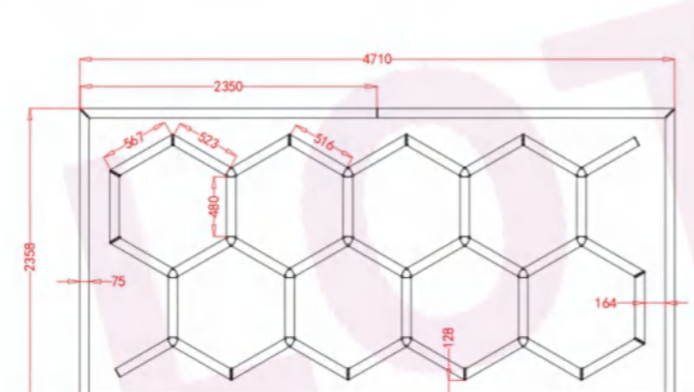

Specification 规格参数	
Model 型号	ZT5068
Size 整灯尺寸	2350mm*4710mm
Voltage 电压	AC100-240V
Width 发光面	80mm
Power 功率	759W
Luminous Flux 光通量	110-120lm/w
CRI 显示指数	>90
CCT. 色温	6500K(White)
Lifespan 使用寿命	50000H/2-years warranty

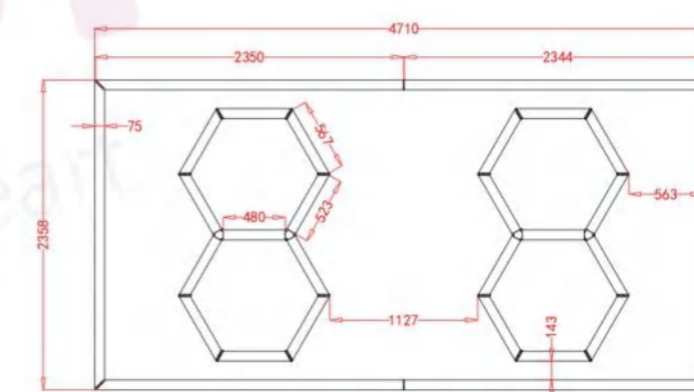

Polygonal Light V3.1 >>>

>>> Polygonal Light V3.1

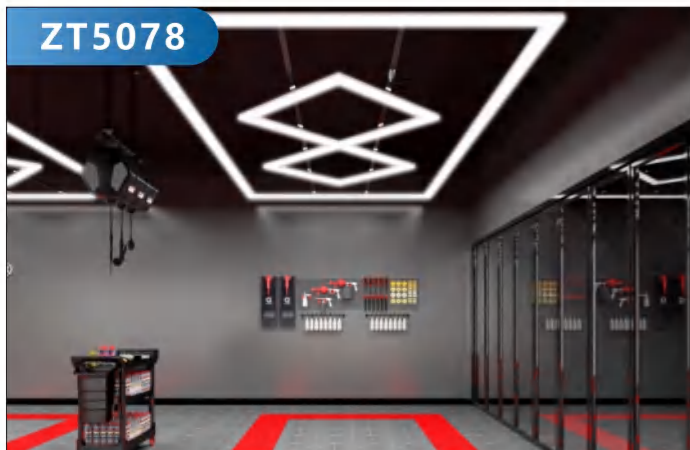

Specification 规格参数	
Model 型号	ZT5078
Size 整灯尺寸	2360mm*4714mm
Voltage 电压	AC100-240V
Width 发光面	80mm
Power 功率	731W
Luminous Flux 光通量	110-120lm/w
CRI 显示指数	>90
CCT. 色温	6500K(White)
Lifespan 使用寿命	50000H/2-years warranty

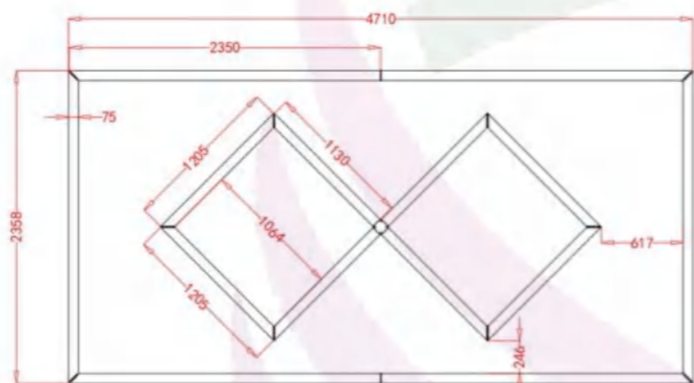

Specification 规格参数	
Model 型号	ZT5088
Size 整灯尺寸	2358mm*4710mm
Voltage 电压	AC100-240V
Width 发光面	80mm
Power 功率	731W
Luminous Flux 光通量	110-120lm/w
CRI 显示指数	>90
CCT. 色温	6500K(White)
Lifespan 使用寿命	50000H/2-years warranty

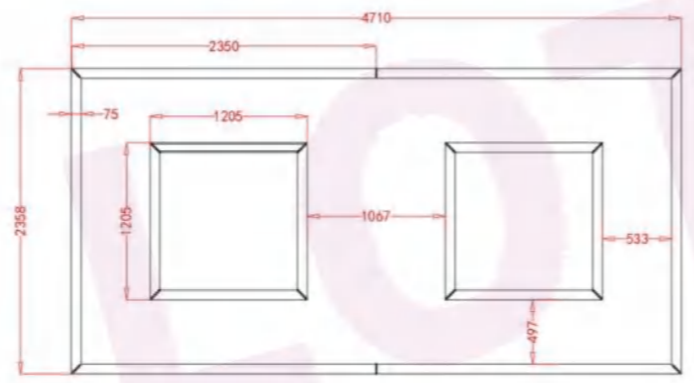

Polygonal Light V5.0 >>>



U-light



智能遥控器

Configure 32 key remote control, whole sets can also be APP remote controlled. 296 types of color changing modes supported, voice controlled, interpretation of all kinds of changes.
配置32键遥控,可与手机APP远程连接控制。支持296种色彩变换,拾音律动,演绎百般变化。

Fireproof PC, High transparency. 3 pins, more stable for the structure, and grounding wire design more safe, one-step connection, copper pins, good for wiring
灯具拼接采用快插接电方式,自动卡位无需手接,安装一步到位,快捷方便,连接头升级改造成三孔,带地线连接,更安全稳定。高透PC面罩设计,光效更均匀。

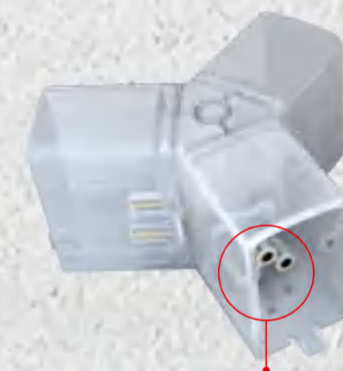

三角形公母头对插设计,结构稳固,带地线连接,达到国标用电标准,更安全

Thickened aluminum, good for heat dissipation and not easy to get damaged. Anti-glare design, and thickened material to make it stable.
灯体采用加厚铝合金材质,高效散热,有效保护灯体使用寿命,同时外壳更稳定,不易变形。



A variety of installation package configurations are available, complete lifting and screw accessories are included, and installation is more time-consuming.
多种安装包配置可选,吊装和螺丝配件包含齐全,安装更省时。



>>> Polygonal Light V5.0



ZTF510-RGB

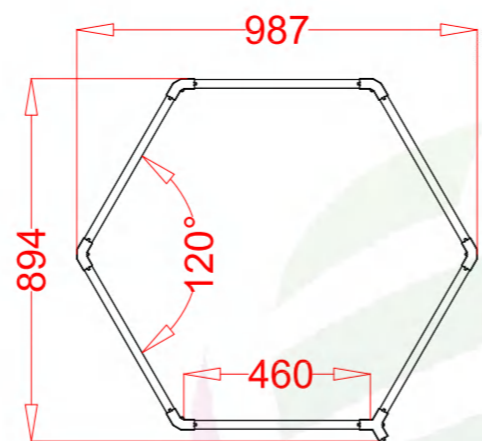

Specification 规格参数	
Model 型号	ZTF510-RGB
Size 整灯尺寸	987mm*894mm
Voltage 电压	AC12V
Width 发光面	20mm
Power 功率	11W
Luminous Flux 光通量	110-120lm/w
CRI 显示指数	>90
CCT. 色温	RGB
Lifespan 使用寿命	50000H/2-years warranty

Accessories	
 <p>【5.0】460mm LightsX6</p>	
 <p>【2.0】120°connector(3-pin)X5</p>	 <p>【2.0】Y-shape connector(3-pin)X1</p>

Polygonal Light V5.0 >>>

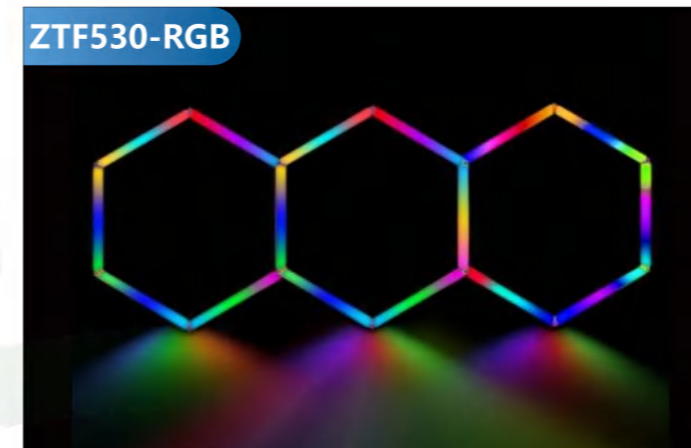

ZTF530-RGB

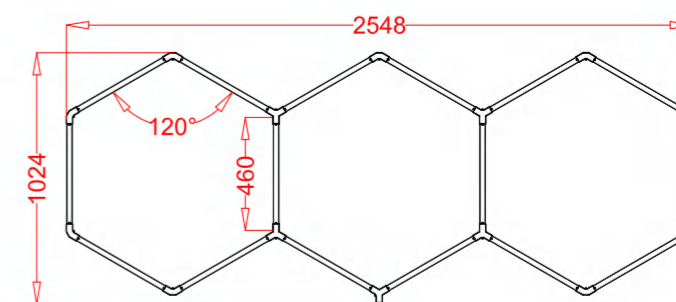

Specification 规格参数	
Model 型号	ZTF530-RGB
Size 整灯尺寸	2548mm*1024mm
Voltage 电压	AC12V
Width 发光面	20mm
Power 功率	29W
Luminous Flux 光通量	110-120lm/w
CRI 显示指数	>90
CCT. 色温	RGB
Lifespan 使用寿命	50000H/2-years warranty

Accessories	
 <p>【5.0】460mm LightsX16</p>	
 <p>【2.0】120°connector(3-pin)X9</p>	 <p>【2.0】X-shape connector(3-pin)X5</p>



ZTF520-RGB

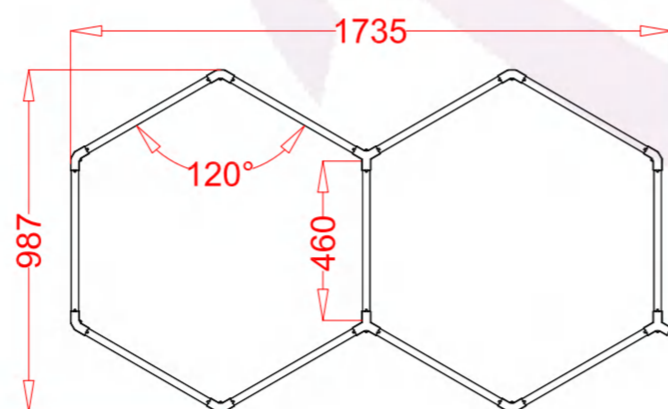

Specification 规格参数	
Model 型号	ZTF520-RGB
Size 整灯尺寸	1735mm*987mm
Voltage 电压	AC12V
Width 发光面	20mm
Power 功率	20W
Luminous Flux 光通量	110-120lm/w
CRI 显示指数	>90
CCT. 色温	RGB
Lifespan 使用寿命	50000H/2-years warranty

Accessories	
 <p>【5.0】460mm LightsX11</p>	
 <p>【2.0】120°connector(3-pin)X7</p>	 <p>【2.0】Y-shape connector(3-pin)X3</p>



ZTF531-RGB

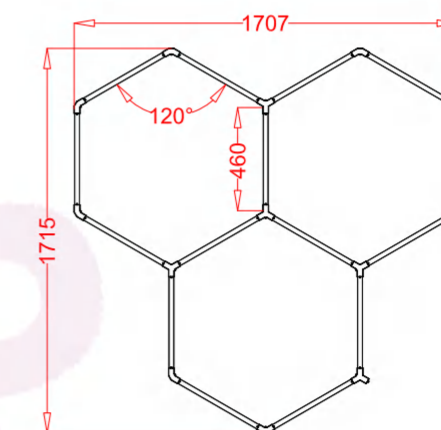

Specification 规格参数	
Model 型号	ZTF531-RGB
Size 整灯尺寸	1707mm*1715mm
Voltage 电压	AC12V
Width 发光面	20mm
Power 功率	27W
Luminous Flux 光通量	110-120lm/w
CRI 显示指数	>90
CCT. 色温	RGB
Lifespan 使用寿命	50000H/2-years warranty

Accessories	
 <p>【5.0】460mm LightsX15</p>	
 <p>【2.0】120°connector(3-pin)X8</p>	 <p>【2.0】X-shape connector(3-pin)X5</p>

>>> Polygonal Light V5.0

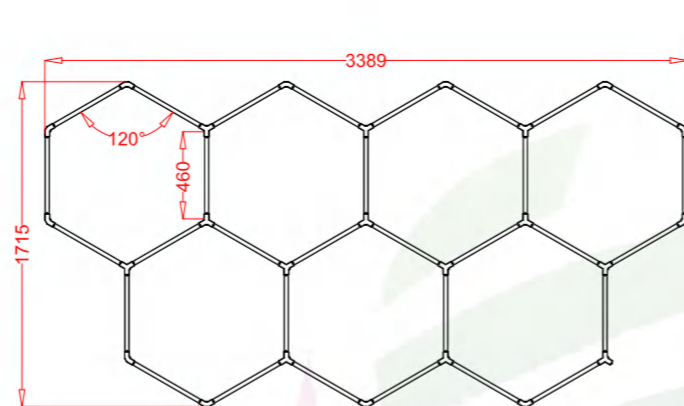
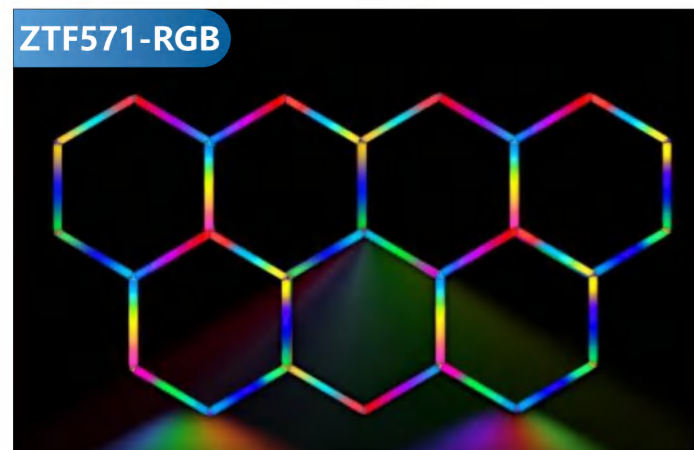

Specification 规格参数	
Model 型号	ZTF571-RGB
Size 整灯尺寸	3389mm*1715mm
Voltage 电压	AC12V
Width 发光面	20mm
Power 功率	56W
Luminous Flux 光通量	110-120lm/w
CRI 显示指数	>90
CCT. 色温	RGB
Lifespan 使用寿命	50000H/2-years warranty

Accessories	
 <p>【5.0】 460mm LightsX31</p>	
 <p>【2.0】 120°connector(3-pin)X12</p>	 <p>【2.0】 Y-shape connector(3-pin)X13</p>

Polygonal Light V5.0 >>>

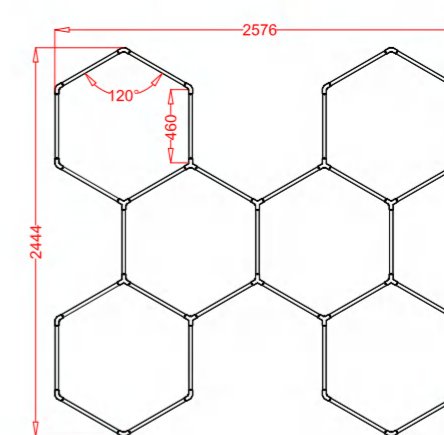

Specification 规格参数	
Model 型号	ZTF563-RGB
Size 整灯尺寸	2576mm*2444mm
Voltage 电压	AC12V
Width 发光面	20mm
Power 功率	56W
Luminous Flux 光通量	110-120lm/w
CRI 显示指数	>90
CCT. 色温	RGB
Lifespan 使用寿命	50000H/2-years warranty

Accessories	
 <p>【5.0】 460mm LightsX31</p>	
 <p>【2.0】 120°connector(3-pin)X15</p>	 <p>【2.0】 Y-shape connector(3-pin)X11</p>

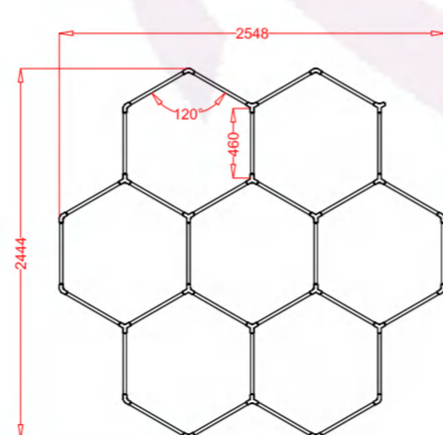

Specification 规格参数	
Model 型号	ZTF572-RGB
Size 整灯尺寸	2548mm*2444mm
Voltage 电压	AC12V
Width 发光面	20mm
Power 功率	54W
Luminous Flux 光通量	110-120lm/w
CRI 显示指数	>90
CCT. 色温	RGB
Lifespan 使用寿命	50000H/2-years warranty

Accessories	
 <p>【5.0】 460mm LightsX30</p>	
 <p>【2.0】 120°connector(3-pin)X11</p>	 <p>【2.0】 Y-shape connector(3-pin)X13</p>

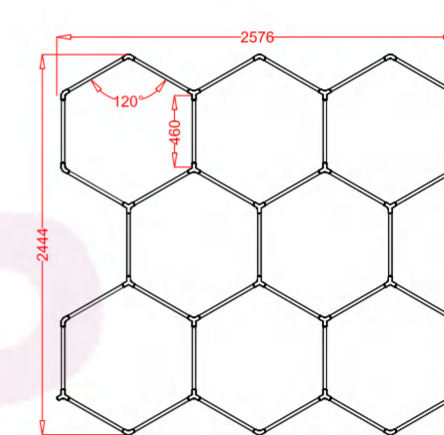

Specification 规格参数	
Model 型号	ZTF582-RGB
Size 整灯尺寸	2576mm*2444mm
Voltage 电压	AC12V
Width 发光面	20mm
Power 功率	63W
Luminous Flux 光通量	110-120lm/w
CRI 显示指数	>90
CCT. 色温	RGB
Lifespan 使用寿命	50000H/2-years warranty

Accessories	
 <p>【5.0】 460mm LightsX35</p>	
 <p>【2.0】 120°connector(3-pin)X14</p>	 <p>【2.0】 Y-shape connector(3-pin)X15</p>

>>> Polygonal Light V5.0



ZTF540-RGB

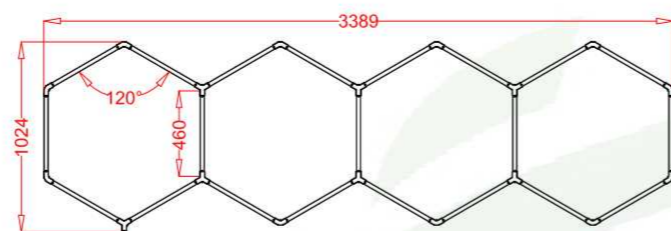

Specification 规格参数	
Model 型号	ZTF540-RGB
Size 整灯尺寸	3389mm*1024mm
Voltage 电压	AC12V
Width 发光面	20mm
Power 功率	38W
Luminous Flux 光通量	110-120lm/w
CRI 显示指数	>90
CCT. 色温	RGB
Lifespan 使用寿命	50000H/2-years warranty

Accessories	
 <p>460mm</p> <p>【5.0】 460mm LightsX21</p>	
 <p>【2.0】 120°connector(3-pin)X11</p>	 <p>【2.0】 Y-shape connector(3-pin)X7</p>

Polygonal Light V5.0 >>>

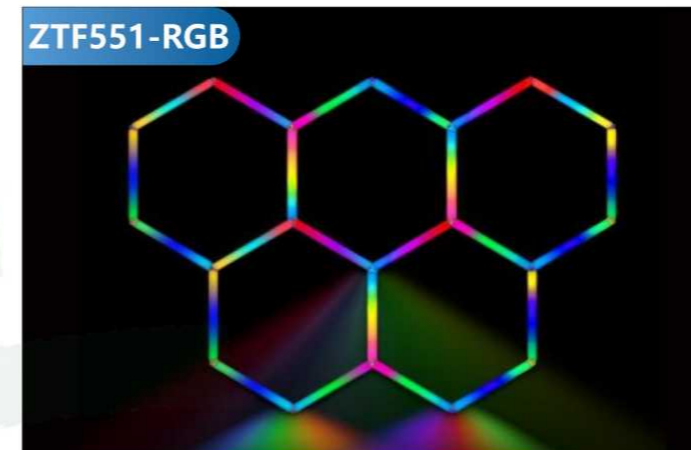

ZTF551-RGB

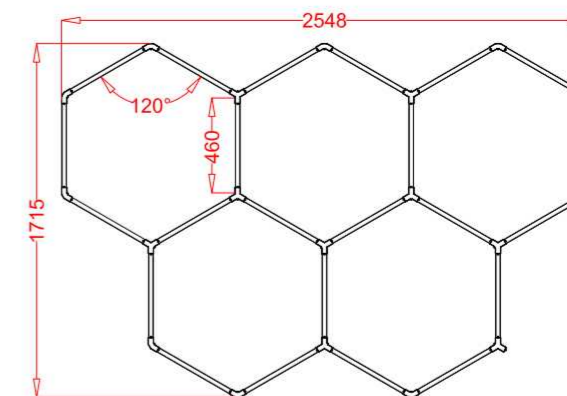

Specification 规格参数	
Model 型号	ZTF551-RGB
Size 整灯尺寸	2548mm*1715mm
Voltage 电压	AC12V
Width 发光面	20mm
Power 功率	42W
Luminous Flux 光通量	110-120lm/w
CRI 显示指数	>90
CCT. 色温	RGB
Lifespan 使用寿命	50000H/2-years warranty

Accessories	
 <p>460mm</p> <p>【5.0】 460mm LightsX23</p>	
 <p>【2.0】 120°connector(3-pin)X10</p>	 <p>【2.0】 Y-shape connector(3-pin)X9</p>



ZTF542-RGB

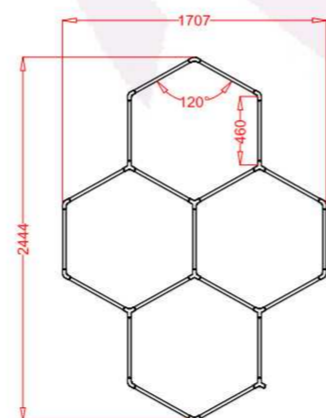

Specification 规格参数	
Model 型号	ZTF542-RGB
Size 整灯尺寸	1707mm*2444mm
Voltage 电压	AC12V
Width 发光面	20mm
Power 功率	34W
Luminous Flux 光通量	110-120lm/w
CRI 显示指数	>90
CCT. 色温	RGB
Lifespan 使用寿命	50000H/2-years warranty

Accessories	
 <p>460mm</p> <p>【5.0】 460mm LightsX19</p>	
 <p>【2.0】 120°connector(3-pin)X9</p>	 <p>【2.0】 Y-shape connector(3-pin)X7</p>



ZTF552-RGB

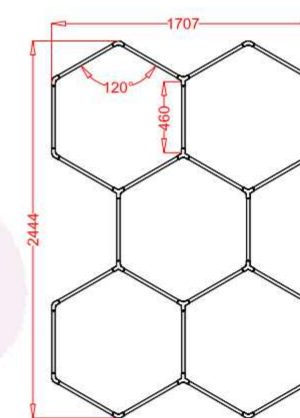

Specification 规格参数	
Model 型号	ZTF552-RGB
Size 整灯尺寸	1707mm*2444mm
Voltage 电压	AC12V
Width 发光面	20mm
Power 功率	43W
Luminous Flux 光通量	110-120lm/w
CRI 显示指数	>90
CCT. 色温	RGB
Lifespan 使用寿命	50000H/2-years warranty

Accessories	
 <p>460mm</p> <p>【5.0】 460mm LightsX24</p>	
 <p>【2.0】 120°connector(3-pin)X12</p>	 <p>【2.0】 Y-shape connector(3-pin)X8</p>